

The background features a stylized globe with a grid of latitude and longitude lines, overlaid with a network of glowing blue and white lines that suggest data flow and connectivity. The overall color palette is dominated by various shades of blue, from light sky blue to deep navy blue.

netsys

Networking your world

NV-700L

Managed Single Master / Slave LAN Extender

USER'S MANUAL

[Http://www.netsys.com.tw](http://www.netsys.com.tw)

Copyright

Copyright © 2018 by National Enhance Technology Corp. All rights reserved.

Trademarks

NETSYS is a trademark of National Enhance Technology Corp.

Other brand and product names are registered trademarks or trademarks of their respective holders.

Legal Disclaimer

The information given in this document shall in no event be regarded as a guarantee of conditions or characteristics. With respect to any examples or hints given herein, any typical values stated herein and/or any information regarding the application of the device, National Enhance Technology Corp. hereby disclaims any and all warranties and liabilities of any kind, including without limitation warranties of non-infringement of intellectual property rights of any third party.

Statement of Conditions

In the interest of improving internal design, operational function, and/or reliability, NETSYS reserves the right to make changes to the products described in this document without notice. NETSYS does not assume any liability that may occur due to the use or application of the product(s) or circuit layout(s) described herein.

Maximum signal rate derived from IEEE Standard specifications. Actual data throughput will vary. Network conditions and environmental factors, including volume of network traffic, building materials and construction, and network overhead, lower actual data throughput rate. Netsys does not warrant that the hardware will work properly in all environments and applications, and makes no warranty and representation, either implied or expressed, with respect to the quality, performance, merchantability, or fitness for a particular purpose. Make sure you follow in line with the environmental conditions to use this product.

Safety Warnings

For your safety, be sure to read and follow all warning notices and instructions before using the device.

- ◆ **DO NOT** open the device or unit. Opening or removing the cover may expose you to dangerous high voltage points or other risks. ONLY qualified service personnel can service the device. Please contact your vendor for further information.
- ◆ **Use ONLY** the dedicated power supply for your device. Connect the power to the right plug type (AC support full range between 100Vac and 240Vac input. 12 Vdc / 1A or above output).
- ◆ **Place** connecting cables carefully so that no one will step on them or stumble over them. **DO NOT** allow anything to rest on the power cord and do **NOT** locate the product where anyone can work on the power cord.
- ◆ **DO NOT** install nor use your device during a thunderstorm. There may be a remote risk of electric shock from lightning.
- ◆ **DO NOT** expose your device to dampness, dust or corrosive liquids.
- ◆ **DO NOT** use this product near water, for example, in a wet basement or near a swimming pool.
- ◆ **Connect ONLY** suitable accessories to the device.
- ◆ **Make sure** to connect the cables to the correct ports.
- ◆ **DO NOT** obstruct the device ventilation slots, as insufficient air flow may harm your device.
- ◆ **DO NOT** place items on the device.
- ◆ **DO NOT** use the device for outdoor applications directly, and make sure all the connections are indoors or have waterproof protection place.
- ◆ **Be careful** when unplugging the power, because it may produce sparks.
- ◆ **Keep** the device and all its parts and accessories out of the reach of children.
- ◆ **Clean** the device using a soft and dry cloth rather than liquid or atomizers. Power off the equipment before cleaning it.
- ◆ This product is **recyclable**. Dispose of it properly.

Attention:

Be sure to read this manual carefully before using this product. Especially Legal Disclaimer, Statement of Conditions and Safety Warnings.

NV-700L is a Managed Single Master/Slave LAN Extender that leverages the extraordinary bandwidth promise of VDSL2 technology (max. 100Mbps symmetric), the next step in the delivery of new high-speed Internet applications in commercial environments. Quick, easy, economical to install and maintain, the NV-700L works over existing copper wire infrastructure. NV-700L is a Master(CO side) device. And also can switch as Slave(CPE side) by web config menu.

NV-700L will allow operators worldwide to compete with cable and satellite operators by offering services such as HDTV, VOD, videoconferencing, high speed Internet access and advanced voice services including VoIP, over a standard copper telephone cable. NV-700L is seen by many operators as an ideal accompaniment to a FTTP rollout, where for instance fiber optic is supplied direct to an apartment block and from there copper cable is used to supply residents with high-speed VDSL2.

Caution:

The NV-700L is for **indoor** applications only. This product does not have waterproof protection, please do not use in outdoor applications.

Table of Contents

COPYRIGHT.....	1
1.1 CHECK LIST	7
CHAPTER 2. INSTALLING THE MODEM	8
2.1 HARDWARE INSTALLATION	8
2.2 PRE-INSTALLATION REQUIREMENTS.....	8
2.3 GENERAL RULES	9
2.4 CONNECTING THE RJ-11 / RJ-45 PORTS	10
2.5 POINT TO POINT APPLICATION	11
CHAPTER 3. HARDWARE DESCRIPTION	13
3.1 FRONT PANEL.....	14
3.2 FRONT INDICATORS	14
3.3 REAR PANEL	16
CHAPTER 4. CONFIGURE THE NV-700L VIA WEB MANAGEMENT MENU.....	18
4.1 BASIC SETUP	19
4.1.1 Login Webpage	19
4.1.2 Display status.....	20
4.2 SELECT THE MENU LEVEL.....	21
4.3 SYSTEM	22
4.3.1 Configuration Backup.....	23
4.3.2 Configuration Restore.....	24

4.3.3 Update Software	25
4.3.4 Account Management	26
4.3.5 Log Level	27
4.3.6 Service Control	28
4.3.7 CWNP (TR-069 Settings)	30
4.3.8 Internet Time	31
4.3.9 Restore Default	32
4.4 STATUS SETUP	33
4.4.1 LAN Network	34
4.4.2 Ethernet	35
4.4.3 WAN(Line) Statistics	36
4.4.4 LAN Statistics	37
4.4.5 ARP	38
4.5 XDSL SETUP	39
4.5.1 Master/Slave mode & profile Config	40
4.5.1.1 VDSL Config Overview	41
4.6 LAN SETUP	42
4.6.1 IPv4 Configuration	43
4.6.2 IPv6 Configuration:	44
4.6.3 IPv6Static Route	45
4.6.4 Ethernet Mode	47
4.7 QOS SETUP	48
4.7.1 Qos Queue	49
4.8 APPLICATIONS	50



NV-700L Managed Single Master / Slave LAN Extender USER'S MANUAL Ver. B.5

4.8.1 Telnet Service Setup(for Security)..... 51

4.8.2 SSH Service(Telnet Encryption)..... 52

4.8.3 Printer Sharing..... 53

4.8.4 Multimedia Sharing..... 54

4.8.5 UPnP..... 55

4.8.6 Multicast IGMP..... 56

4.8.7 Multicast MLD (IPv6)..... 57

4.8.8 SNMP..... 58

4.9 USB SETUP..... 61

4.9.1 Storage Device Info 62

4.9.2 Samba Service..... 63

4.9.3 FTP Server..... 64

4.9.4 FTP Client..... 65

4.9.5 TFTP Server..... 68

APPENDIX A: CABLE REQUIREMENTS..... 69

APPENDIX B: PRODUCT SPECIFICATION..... 72

APPENDIX C: TROUBLESHOOTING..... 76

APPENDIX E: COMPLIANCE INFORMATION..... 83

WARRANTY..... 86

CHINESE SJ/T 11364-2014..... 87

Chapter 1. Unpacking Information

1.1 Check List

Thank you for choosing Netsys NV-700L Before installing the router, please verify the contents inside the package.

Package Contents:

			
<p>1 x VDSL2 CO Modem</p>	<p>1 x QR code for user's manual hyperlink.</p>	<p>Accessory Kit : 1 x Ethernet Cable, 1 x Phone wire , 1 x DC12V Power Adapter</p>	

Notes:

1. Please inform your dealer immediately for any missing or damaged parts. If possible, retain the carton including the original packing materials. Use them to repack the unit in case there is a need to return for repair.
2. Do not use sub-standard power supply. Before connecting the power supply to the device, be sure to check compliance with the specifications. The NV-700L uses a DC12V/1A or above Switching power supply.

Chapter 2. Installing the Modem

2.1 Hardware Installation

This chapter describes how to install the modem, and establish the network connections. The NV-700L may be installed on any level surface (e.g. a table or shelf). However, please take note of the following minimum site requirements before you begin. **The NV-700L has 2 pre-installed rubber feet.**

2.2 Pre-installation Requirements

Before you start the actual hardware installation, make sure you can provide the right operating environment, including power requirements, sufficient physical space, and proximity to other network devices that are to be connected.

Verify the following installation requirements:

- Power requirements: **DC 12 V / 1A**
- The modem should be located in a cool dry place, with at least **10cm/4in** of space at the front and back for ventilation.
- Place the modem away from direct sunlight, heat sources, or areas with a high amount of electromagnetic interference.
- Check if the network cables and connectors needed for installation are available.
- **Do not install phone lines strapped together with AC power lines, or telephone office line with voice signal.**
- **Avoid installing this device with radio amplifying stations nearby or transformer stations nearby.**

2.3 General Rules

Before making any connections to the modem, please note the following rules:

- **Ethernet Port interface : RJ-45**

All network connections to the modem Ethernet port must be made using Category 5 UTP/STP or above for 100 Mbps, Category 3, 4 UTP for 10Mbps.

No more than 100 meters of cabling may be use between the MUX or HUB and an end node.

- **VDSL2 Port interface : RJ-11 & Terminal block combo**

All network connections to the RJ-11/ terminal block(sharing port) must use **24~26** gauge with single **twisted pair** phone wire.

We **do not recommend** the use of the 28 gauge phone wire or above.

The RJ-11 is an 6P2C connector, two of which are wired. The modem uses the center two pins. The pin out assignment for these connectors is presented below.

Please note that the line port is no polarity, therefore user can reverse the two wires of the phone cable when installed.

RJ-11 Pin out Assignments

Pin#	MNEMONIC	FUNCTION
1	NC	Unused
2	NC	Unused
3	DSL	Used
4	DSL	Used
5	NC	Unused
6	NC	Unused

2.4 Connecting the RJ-11 / RJ-45 Ports

- ◆ The line port have 1 connector: RJ-11 . It is used to connect with NV-700L Master side over a single pair phone wire to NV-700L Slave side (point to point application). (Figure 2.1)

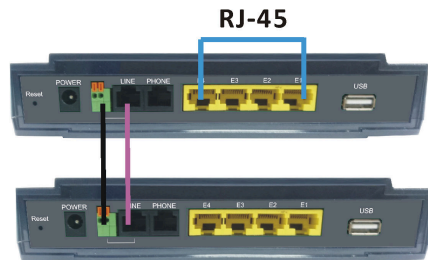

Black Line: Valid
Red Line: Valid

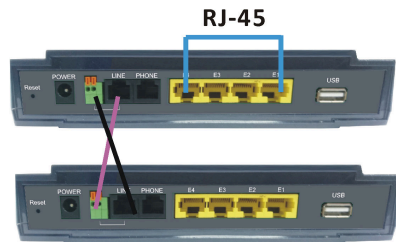

Black Line: Valid
Red Line: Valid
Black+Red : Invalid

Figure 2.1 NV-700L line ports straight connection

- ◆ When inserting a RJ-11 plug, make sure the tab on the plug clicks into position to ensure that it is properly seated.
- ◆ **Do not** plug a RJ-11 phone jack connector into the Ethernet port (RJ-45 port). This may damage the modem. Instead, use only twisted-pair cables with RJ-45 connectors that conform to Ethernet standard.

Notes:

1. Be sure each twisted-pair cable (RJ-45 Ethernet cable) does not exceed 100 meters (333 feet).
2. We advise using Category 5~7 UTP/STP cables for making Ethernet connections to avoid any confusion or inconvenience in the future when you attach high bandwidth devices.
3. Use **24 ~ 26** gauge twisted pair phone wiring, we do not recommend 28 gauge or above.
4. Be sure phone wire has been installed before the NV-700L boot.
5. Do not connect Line port with RJ-11 and Terminal block to two Master / Slave device

2.5 Point to Point Application

First a quick overview on a complete setup of LAN extender Master/Slave LAN extender.

NV-700L is a LAN extender leverages the extraordinary bandwidth promise of VDSL2 technology (max. 100Mbps Symmetric) (Figure 2.2)

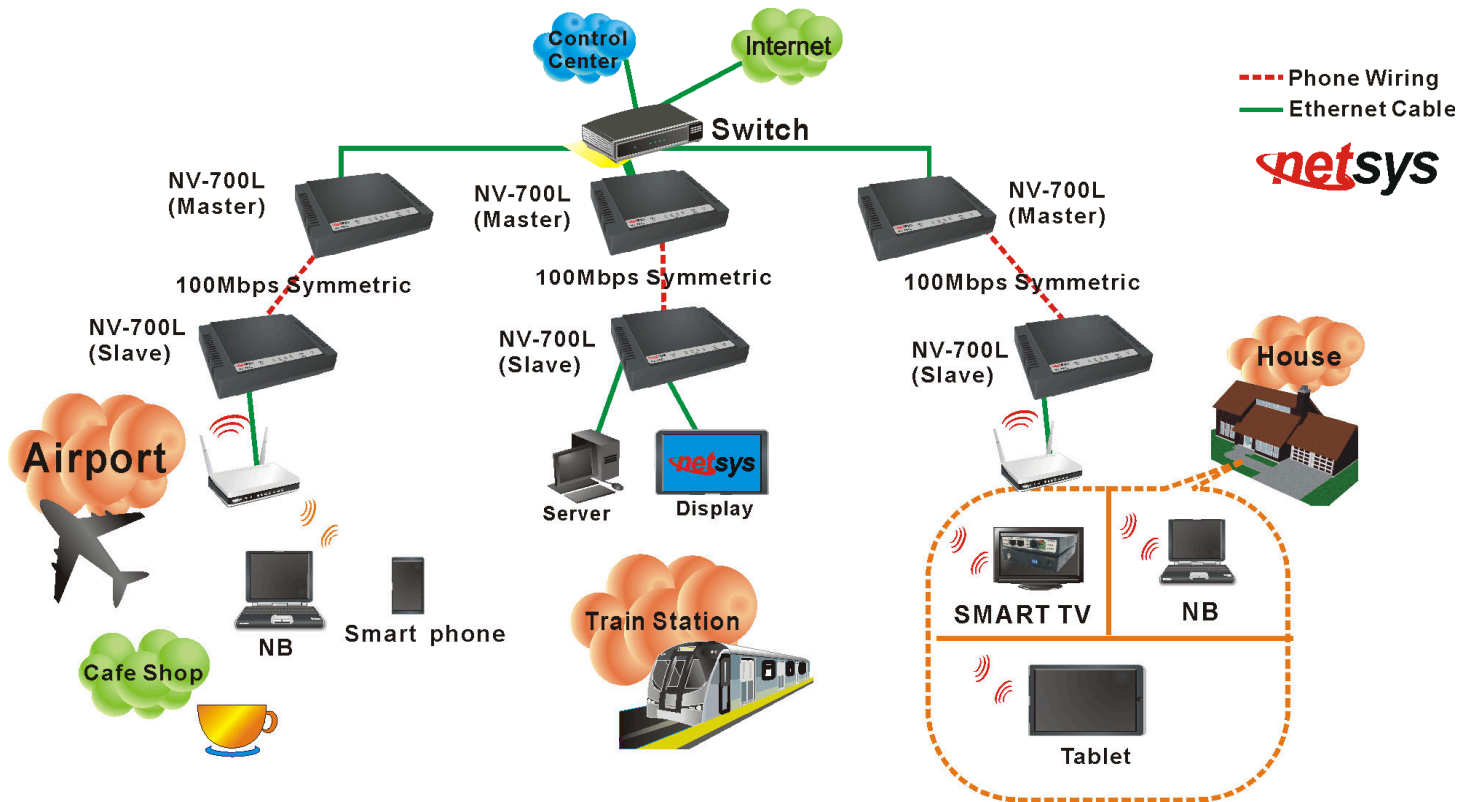

Figure 2.2 NV-700L Point to Point application

◆ **2.5.1 Connect the NV-700L(Master) and the NV-700L(Slave) to the Line**

The objective for LAN extender is to pass high speed data over a twisted pair cable. In the setup, connect NV-700L(Master) to NV-700L (Slave) through phone wire(24~26 AWG) or line simulator or any other hardware representation of a cable network, with or without noise injection and crosstalk simulations.

◆ **2.5.2 Connect the NV-700L(Master) and the NV-700L(Slave) to LAN Devices**

In the setup, usually an Ethernet tester serves as a representation of the LAN side as well as a representation of the WAN(Line) side.

◆ **2.5.3 Run Demos and Tests**

The Ethernet tester may send data downstream as well as upstream. It also receives the data in order to check the integrity of the data transmission. Different data rates can be tested under different line conditions

Chapter 3. Hardware Description

This section describes the important parts of the NV-700L. It features the front panel and rear panel.



NV-700L Outward

3.1 Front Panel

The figure shows the front panel. (Figure 3.1)

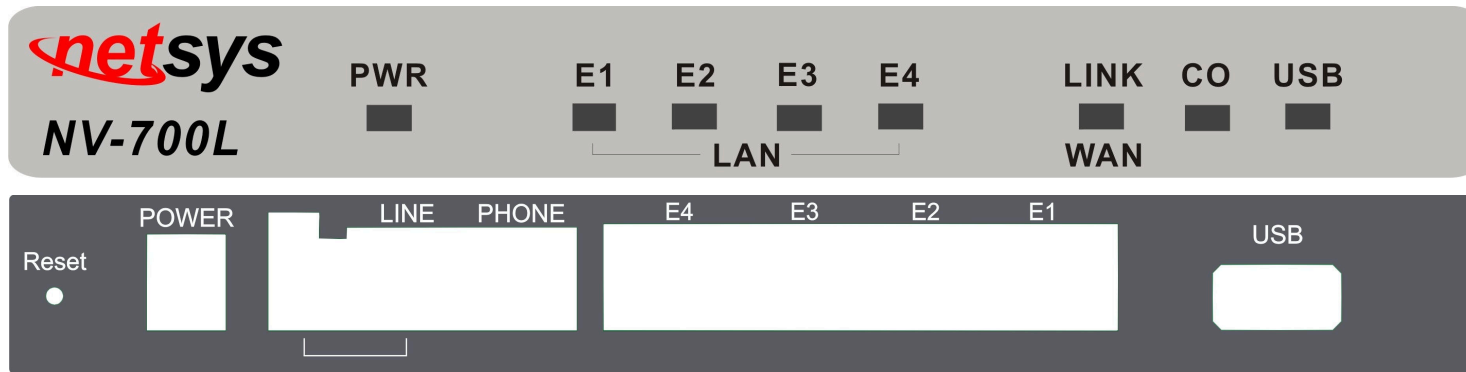

Figure 3.1 Front Panel(NV-700L)

3.2 Front Indicators

The Modem has **Seven** LED indicators. The following Table shows the description. (Table 3-1)

Table 3-1 LED Indicators Description and Operation

LED	Color	Status	Descriptions
PWR (Power LED)	Green	On(Steady)	Lights to indicate that modem had power good
		Off	The device is not ready or has malfunctioned.

LED	Color	Status	Descriptions
E1 ~ E4 (Ethernet LED)	Green	On(Steady)	The device has a good Ethernet connection.
		Blinking	The device is sending or receiving data.
		Off	The LAN is not connected or has malfunctioned.
LINK (Line LED)	Green	On(Steady)	The Internet or network connection is up.
		Fast Blinking	1. The Master device has detected a Slave device and ready to connect. 2. The device is sending or receiving data.
		Off	The Internet or network connection is down.
USB	Green	On (Steady)	The device has a good USB dongle connection.
		Off	The device is not ready or has malfunctioned.
CO	Green	On (Steady)	NV-700L config on Master mode.
		Off	NV-700L config on Slave mode

Note:

It is normal for the connection between two NV-700L to take up to 3 minutes, due to NV-700L(Master) connect NV-700L(Slave) to establish a link mechanism in auto-speed, with detects and calculates Master and Slave both PBO and PSD level, noise levels and other arguments for getting a better connection.

3.3 Rear Panel

The following figure shows the rear panel. (Figure 3.2)

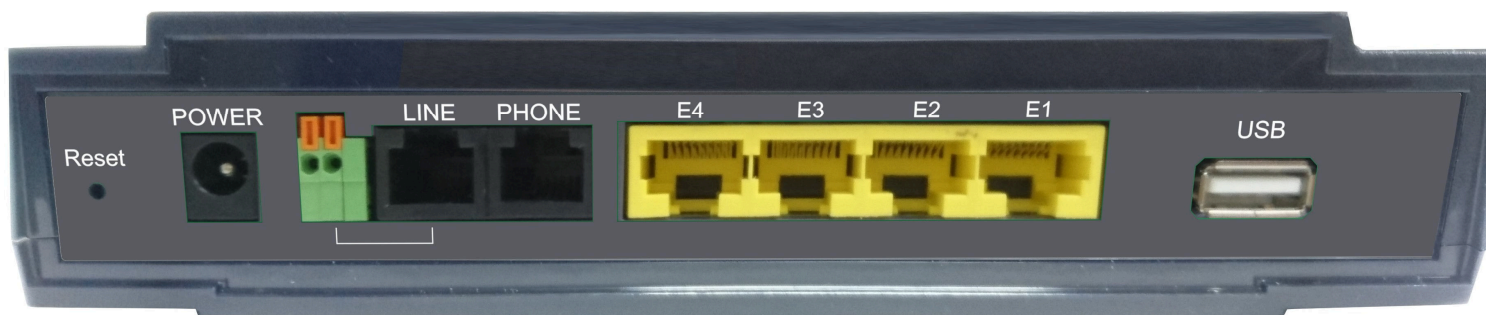

Figure 3.3 Rear Panel

And the table shows the description. (Table 3-2)

Table 3-2 Description of the modem rear connectors

Type	Connector	Description
Reset	Tact Switch Button	The reset buttons allows users to reboot the LAN NV-700L or load the default settings. Press and hold for 1-5 seconds: Reboot the NV-700L Press over 5 seconds: Load the default settings
Power	DC Jack	External switching Power Adapter: Input: AC 100~240Volts/50~60Hz. Output: DC 12V/1A.
Line	RJ-11	For connecting to a Master/Slave device.

Type	Connector	Description
phone	RJ-11	For connecting to the POTS equipment or ISDN.
Ethernet (E1-E4)	RJ-45	For connecting to an Ethernet equipped device.
USB	USB2.0 Type A	For connecting to the USB dongle.

Before user installed power and device, please read and follow these essentials:

- ◆ Use separate paths to route wiring for power and devices. If power wiring and device wiring paths must cross, make sure the wires are perpendicular at the intersection point.

Note:

Do not run signal or communications wiring and power wiring through the same wire conduit. To avoid interference, wires with different signal characteristics should be routed separately.

- ◆ You can use the type of signal transmitted through a wire to determine which wires should be kept separate. The rule of thumb is that wiring sharing similar electrical characteristics can be bundled together.
- ◆ You should separate input wiring from output wiring.
- ◆ We recommend that you mark all equipment in the wiring system.

Chapter 4. Configure the NV-700L via Web management menu

The NV-700L provides a built-in HTML based management interface that allows configuration of the NV-700L via Internet Browser. Best viewed using Chrome or Firefox browsers.

In order to use the web browser to configure the device, you may need to allow:

- Web browser pop-up windows from your device. Web pop-up blocking is enabled by default in windows XP SP2 or above.
- Java Scripts. (Enabled by default)
- Java permissions. (Enabled by default)

Launch your web browser and input the default IP address **192.168.16.249** (NV-700L) in the Web page. Following section user can find default username and password.

4.1 BASIC Setup

4.1.1 Login Webpage

The default username and password are “admin”.

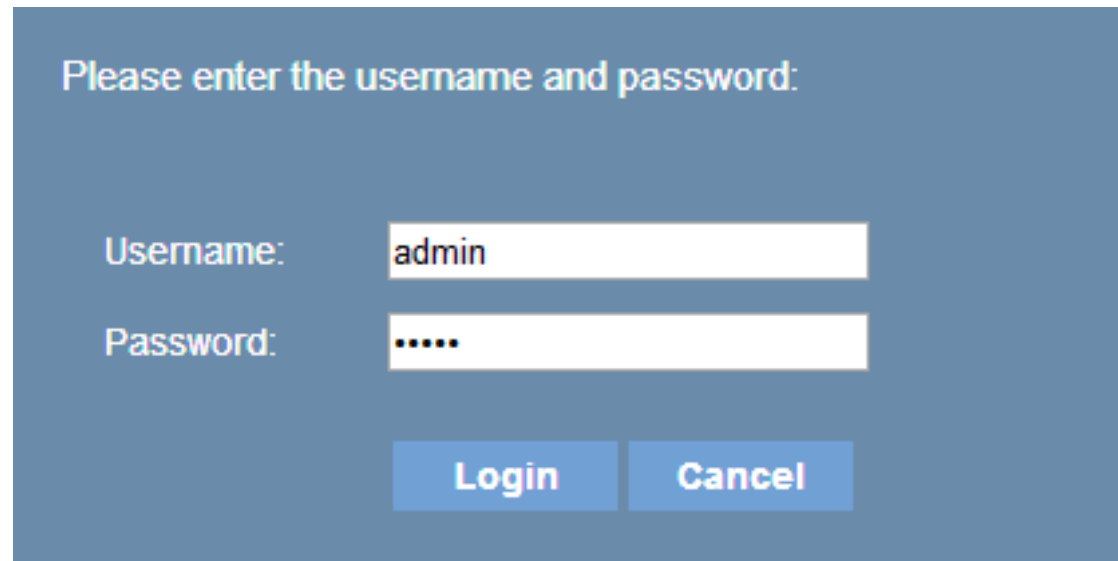

The image shows a login webpage with a blue background. At the top, it says "Please enter the username and password:". Below this, there are two input fields. The first is labeled "Username:" and contains the text "admin". The second is labeled "Password:" and contains six dots. At the bottom, there are two buttons: "Login" and "Cancel".

Figure 4.1.1 Login Webpage

4.1.2 Display status

When the device is running, the status page will display the device informations (Hardware/Software Version, MAC Address, and System Up Time), as shown in [Figure 4.1.2](#).

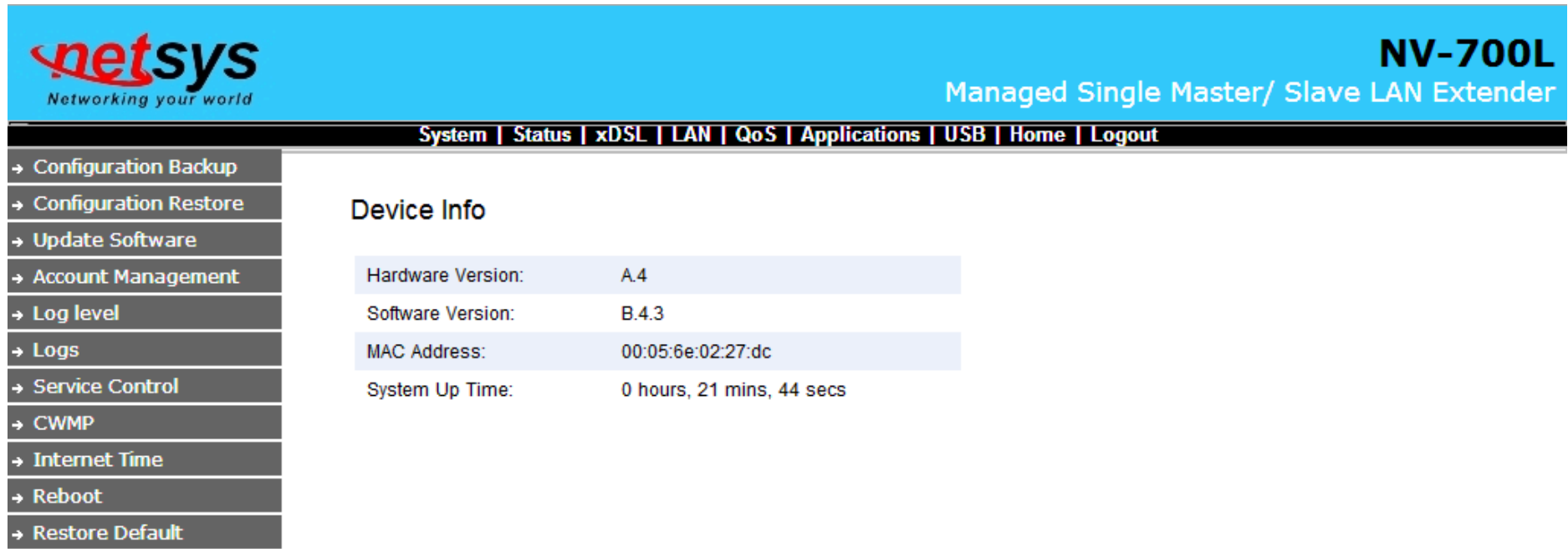

The screenshot shows the web interface for the NV-700L Managed Single Master/ Slave LAN Extender. The top navigation bar includes the netsys logo and the device model name. A secondary navigation bar contains links for System, Status, xDSL, LAN, QoS, Applications, USB, Home, and Logout. A left sidebar menu lists various configuration options. The main content area displays the 'Device Info' section with the following details:

Device Info	
Hardware Version:	A.4
Software Version:	B.4.3
MAC Address:	00:05:6e:02:27:dc
System Up Time:	0 hours, 21 mins, 44 secs

Figure 4.1.2 Device Info

4.2 Select the Menu Level

There is an easy Setup for end users at the setup of NV-700L with **System, Status, xDSL, LAN, Qos, Applications, USB, Home, Logout** for more detail configurations.

The screenshot displays the web interface of the NV-700L. At the top, a navigation bar contains the following menu items: **System | Status | xDSL | LAN | QoS | Applications | USB | Home | Logout**. Below this bar is a vertical sidebar menu with the following options: **→ Configuration Backup**, **→ Configuration Restore**, **→ Update Software**, **→ Account Management**, **→ Log level**, **→ Logs**, **→ Service Control**, **→ CWMP**, **→ Internet Time**, **→ Reboot**, and **→ Restore Default**. The main content area is titled **Device Info** and contains the following information:

Hardware Version:	A.4
Software Version:	B.4.3
MAC Address:	00:05:6e:02:27:dc
System Up Time:	0 hours, 21 mins, 44 secs

Figure 4.2 Select the Menu Level

4.3 System

Select "System". The menu below will be used frequently. It includes the sub-menus of Configuration Backup, Configuration Restore, Update Software, Account Management, Log level, Logs, Service Control, CWMP, Internet Time, Reboot, Restore Default. A screen is displayed as shown in Figure 4.3

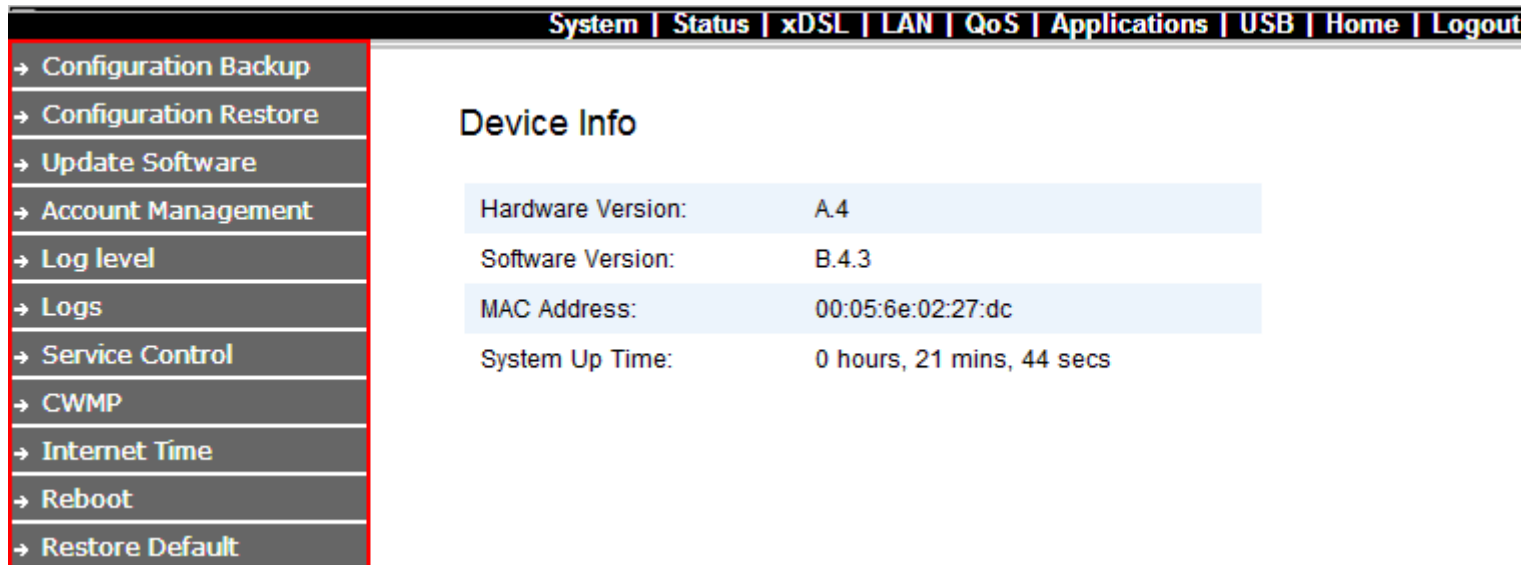

Figure 4.3 System

4.3.1 Configuration Backup

To backup the configuration setting value, click on the “Configuration Backup” link in the left navigation bar. A screen is displayed as shown in [Figure 4.3.1](#).

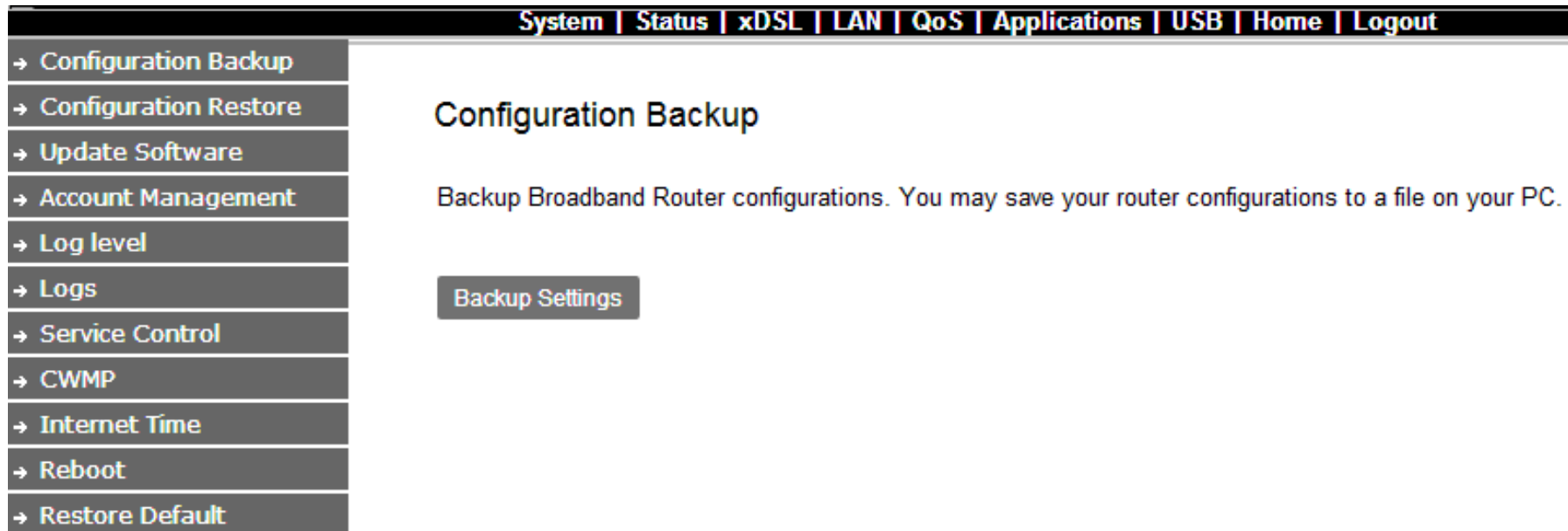

Figure 4.3.1 Configuration Backup

4.3.2 Configuration Restore

To restore your configuration setting value, click on the “Configuration Restore” link in the left navigation bar. A screen is displayed as shown in [Figure 4.3.2](#).

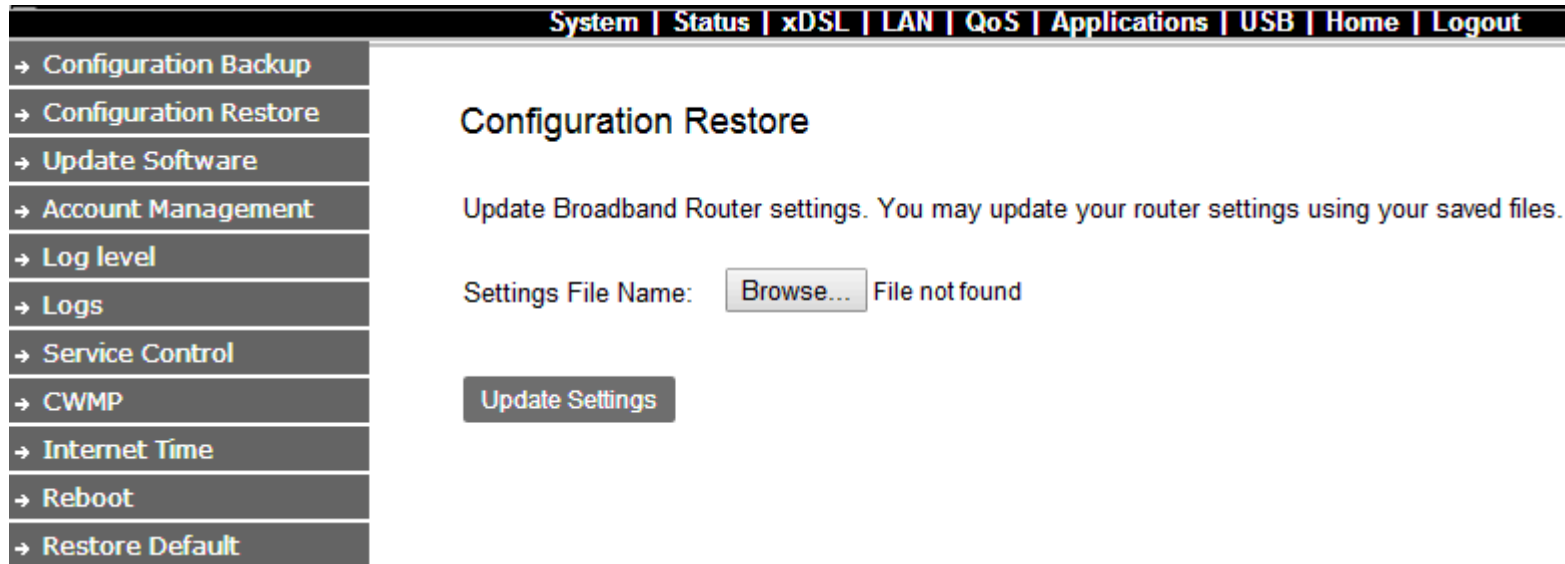

Figure 4.3.2 Configuration Restore

The screen contains the following detail:

- Click "Browse" to select a specific file name in preparation for router settings.
- Click “Update Settings” to start updating.

4.3.3 Update Software

To update software, click on the “Update Software” link in the left navigation bar and follow the steps for updating. A screen is displayed as shown in [Figure 4.3.3](#).

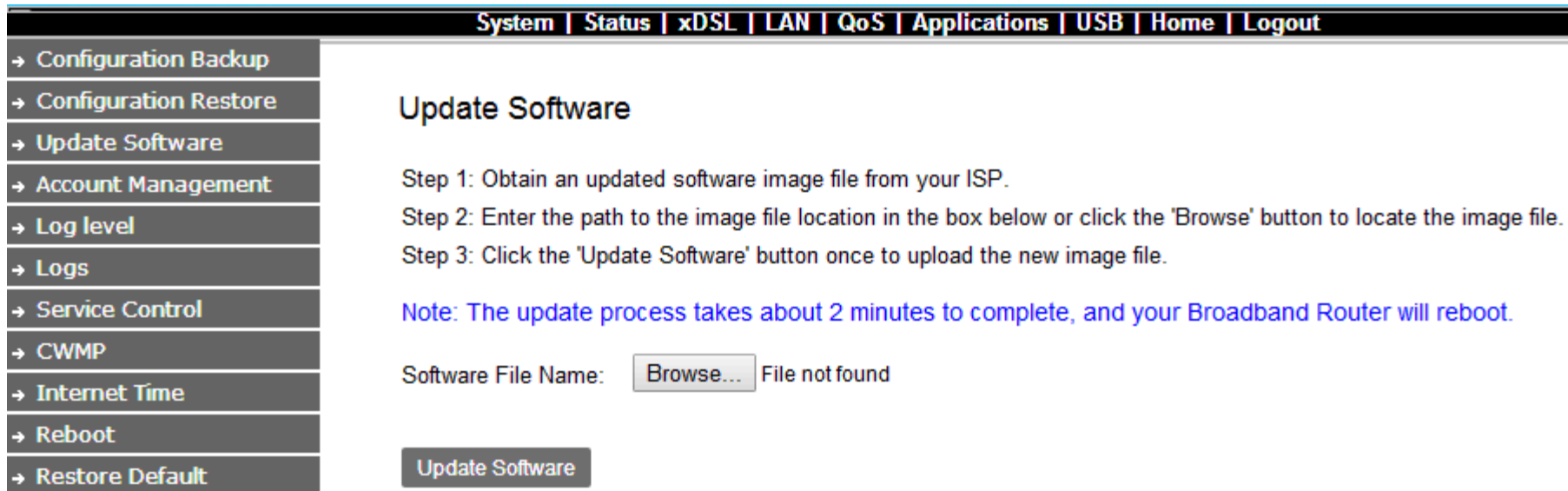

Figure 4.3.3 Update Software

Note:

The update process takes about 12 minutes to complete, and your Broadband Router will reboot.

4.3.4 Account Management

To change or create passwords, click on the “Account Management” link in the left navigation bar. A screen is displayed as shown in [Figure 4.3.4](#).

System | Status | xDSL | LAN | QoS | Applications | USB | Home | Logout

→ Configuration Backup
→ Configuration Restore
→ Update Software
→ Account Management
→ Log level
→ Logs
→ Service Control
→ CWMP
→ Internet Time
→ Reboot
→ Restore Default

Account Management - Passwords

Use the fields below to enter up to 15 characters and click "Apply" to change or create passwords.

Note: Password cannot contain a space.

Username:

Old Password:

New Password:

Confirm Password:

Figure 4.3.4 Account Management-Password

4.3.5 Log Level

Click on the “Log level” link in the left navigation bar, on the right page you will see how to enable Log or Log Server.

A screen is displayed as shown in [Figure 4.3.5](#).

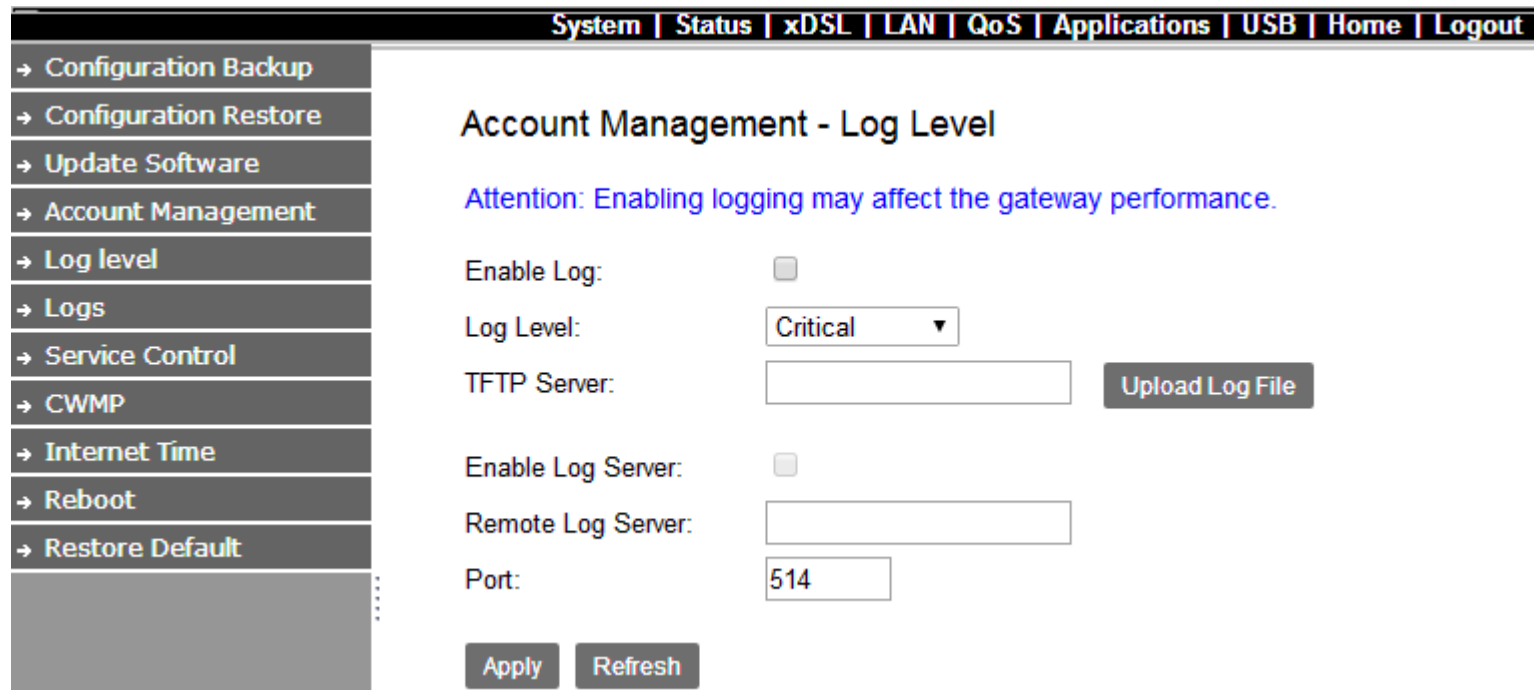

Figure 4.3.5 Account Management – Log Level

4.3.6 Service Control

Click on “Service Control” link in the left navigation bar, on the right page you will see how to enable ACL.

Click “add” to config Protocol / IP Protocol Type / Enable / Action and basic information. A screen is displayed as shown in [Figure 4.3.6](#).

System | Status | xDSL | LAN | QoS | Applications | USB | Home | Logout

→ Configuration Backup
→ Configuration Restore
→ Update Software
→ Account Management
→ Log level
→ Logs
→ **Service Control**
→ CWMP
→ Internet Time
→ Reboot
→ Restore Default

Access Control -- IP Address Configuration

ACL Enable Apply

Add

Service Type:	Access Direction	Protocol	IP Range	Status	Action	Method
HTTP	LAN	IPv4	Any	Enable	ACCEPT	
TELNET	LAN	IPv4	Any	Enable	ACCEPT	
SSH	LAN	IPv4	Any	Enable	ACCEPT	
FTP	LAN	IPv4	Any	Enable	ACCEPT	
TFTP	LAN	IPv4	Any	Enable	ACCEPT	
ICMP	LAN	IPv4	Any	Enable	ACCEPT	
SAMBA	LAN	IPv4	Any	Enable	ACCEPT	
SNMP	LAN	IPv4	Any	Enable	ACCEPT	

System | Status | xDSL | LAN | QoS | Applications | USB | Home | Logout

→ Configuration Backup
→ Configuration Restore
→ Update Software
→ Account Management
→ Log level
→ Logs
→ Service Control
→ CWMP
→ Internet Time
→ Reboot
→ Restore Default

Access Control -- IP Address Configuration

Protocol: HTTP ▾
Port: 80
Access Control: LAN ▾
IP Protocol Type: IPv4 ▾
Enable:
Source IP: -
Action: ACCEPT ▾

Back Apply Refresh

Figure 4.3.6 Service Control – IP Address Configuration

4.3.7 CWNP (TR-069 Settings)

Click on “CWMP” link in the left navigation bar to create TR-069 connection, and setup ACS URL/ ACS User Name/ACS Password and basic information. A screen is displayed as shown in [Figure 4.3.7](#).

System Status xDSL LAN QoS Applications USB Home Logout	
→ Configuration Backup	
→ Configuration Restore	
→ Update Software	
→ Account Management	
→ Log level	
→ Logs	
→ Service Control	
→ CWMP	
→ Internet Time	
→ Reboot	
→ Restore Default	
	<h3>TR069 Settings</h3> <p>Enable TR069: <input type="checkbox"/></p> <p>ACS URL: <input type="text" value="http://acs.demo.co.th:7005/acsmgt"/></p> <p>ACS User Name: <input type="text" value="net"/></p> <p>ACS Password: <input type="password" value="....."/></p> <p>Period Inform: <input checked="" type="checkbox"/></p> <p>Inform Interval: <input type="text" value="86400"/></p> <p>Connection Request Authentication: <input checked="" type="checkbox"/></p> <p>User Name: <input type="text" value="net"/></p> <p>Password: <input type="password" value="....."/></p> <p>Connection Request Port: <input type="text" value="7547"/></p> <p>Connection Request URL: <input type="text" value="/tr069"/></p> <p><input type="button" value="Apply"/> <input type="button" value="Refresh"/></p>

Figure 4.3.7 TR069 Settings

4.3.8 Internet Time

If SNTP server could not be connected to allow the device to synchronize the system clock to the global Internet. Please setup "Internet Time". A screen is displayed as shown in [Figure 4.3.8](#).

The screenshot shows a web interface for configuring time settings. At the top, there is a navigation bar with links: System | Status | xDSL | LAN | QoS | Applications | USB | Home | Logout. On the left, a sidebar menu contains: Configuration Backup, Configuration Restore, Update Software, Account Management, Log level, Logs, Service Control, CWMP, Internet Time (highlighted), Reboot, and Restore Default. The main content area is titled 'Time Settings' and contains the following fields:

- Current Time: 1970-01-01T00:31:05 GMT +08:00
- Time Service Enable:
- Synchronization Status: Unsynchronized
- Time Server 1: time1.google.com
- Time Server 2: 216.239.35.12
- Time Server 3: (empty)
- Time Server 4: (empty)
- Time Server 5: (empty)
- Update Interval: 86400 (Seconds)
- Retry Interval: 60 (Seconds)
- Time Zone: (GMT+08:00) Beijing, Hong Kong
- Daylight-Saving:
- Start Time: 1970 04 01 02 00 00
- End Time: 1970 09 01 02 00 00

At the bottom of the form are two buttons: 'Apply' and 'Refresh'.

Figure 4.3.8 NTP Settings

4.3.9 Restore Default

Setting to the factory defaults, click on the “Restore Default” link in the left navigation bar, and press “Restore Default Settings”, the device will reboot in 10 seconds. A screen is displayed as shown in [Figure 4.3.9](#).

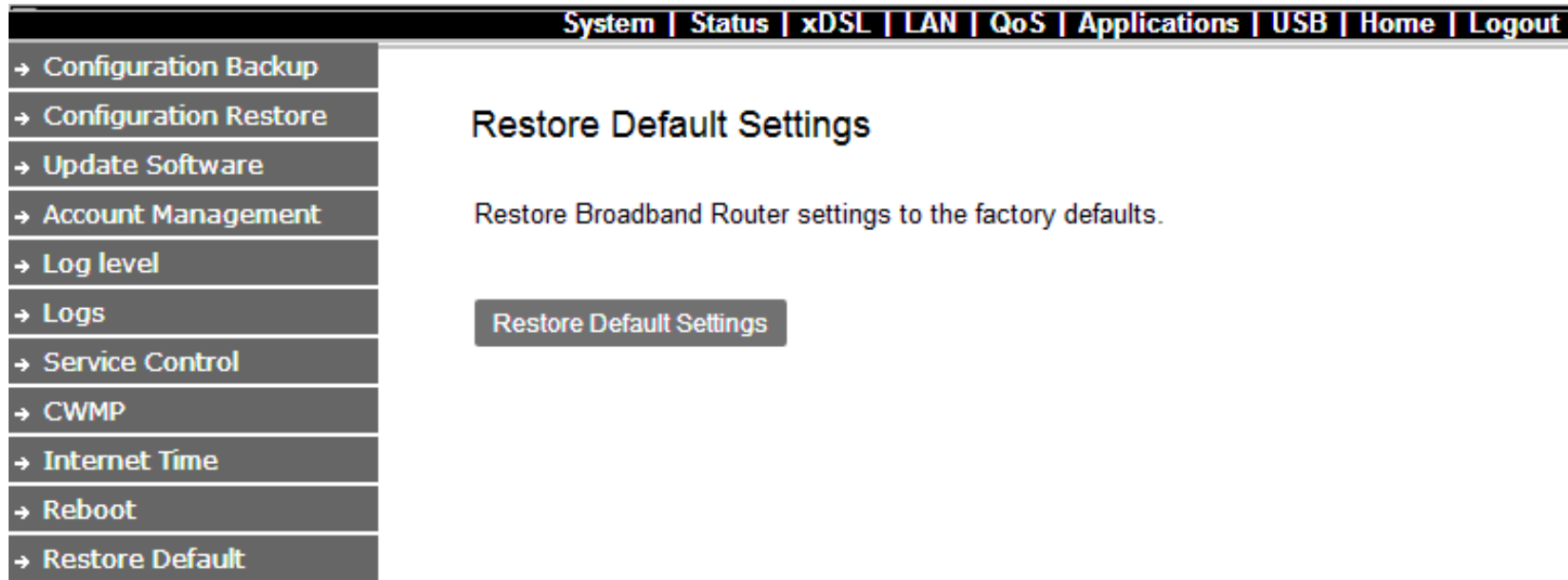

Figure 4.3.9 Restore Default Settings

4.4 Status Setup

Select "Status". It includes the sub-menus of **Device Information**、**LAN Network**、**Ethernet**、**WAN Statistics**、**LAN Statistics**、**ARP**. A screen is displayed as shown in [Figure 4.4](#)

The screenshot shows a web interface with a top navigation bar containing: System | Status | xDSL | LAN | QoS | Applications | USB | Home | Logout. On the left, a vertical menu lists: → Device Information, → LAN Network, → Ethernet, → WAN Statistics, → LAN Statistics, and → ARP. The main content area is titled "Device Info" and displays the following data:

Hardware Version:	A.4
Software Version:	B.4.3
MAC Address:	00:05:6e:02:27:dc
System Up Time:	19 hours, 41 mins, 55 secs

Figure 4.4 Device informations

4.4.1 LAN Network

Click on the “LAN Network” link in the left navigation bar, you will see the status of IPv4/IPv6 Address for this device. A screen is displayed as shown in [Figure 4.4.1](#).

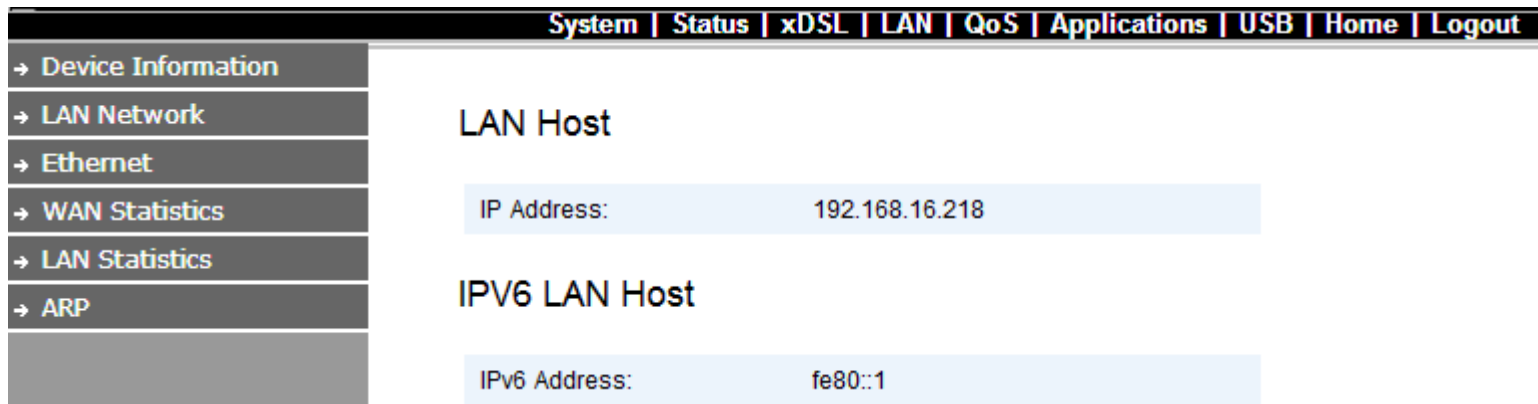

Figure 4.4.1 LAN Network information

4.4.2 Ethernet

Click on the “Ethernet” link in the left navigation bar, you will see the Ethernet Status, Speed, and Duplex of LAN1, LAN2, LAN3, LAN4 for this device. A screen is displayed as shown in [Figure 4.4.2](#).

System Status xDSL LAN QoS Applications USB Home Logout			
→ Device Information			
→ LAN Network			
→ Ethernet			
→ WAN Statistics			
→ LAN Statistics			
→ ARP			

LAN - Ethernet			
Interface	Status	Speed	Duplex
LAN1	Up	100Mb/s	Full Duplex
LAN2	Down	-	-
LAN3	Down	-	-
LAN4	Up	100Mb/s	Full Duplex

Figure 4.4.2 LAN-Ethernet information

4.4.3 WAN(Line) Statistics

Click on the “WAN Statistics” link in the left navigation bar, you will see the Received and Transmitted status for this device. A screen is displayed as shown in [Figure 4.4.3](#).

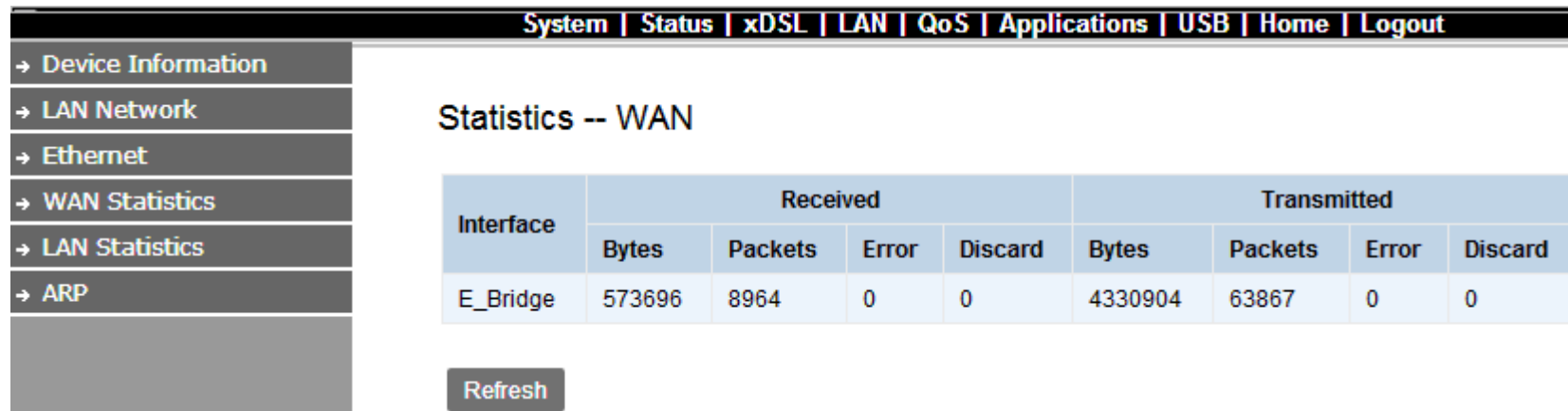

Figure 4.4.3 Statistics—WAN(Line)

4.4.4 LAN Statistics

Click on the “LAN Statistics” link in the left navigation bar, you will see the Received and Transmitted status for LAN1~4. A screen is displayed as shown in [Figure 4.4.4](#).

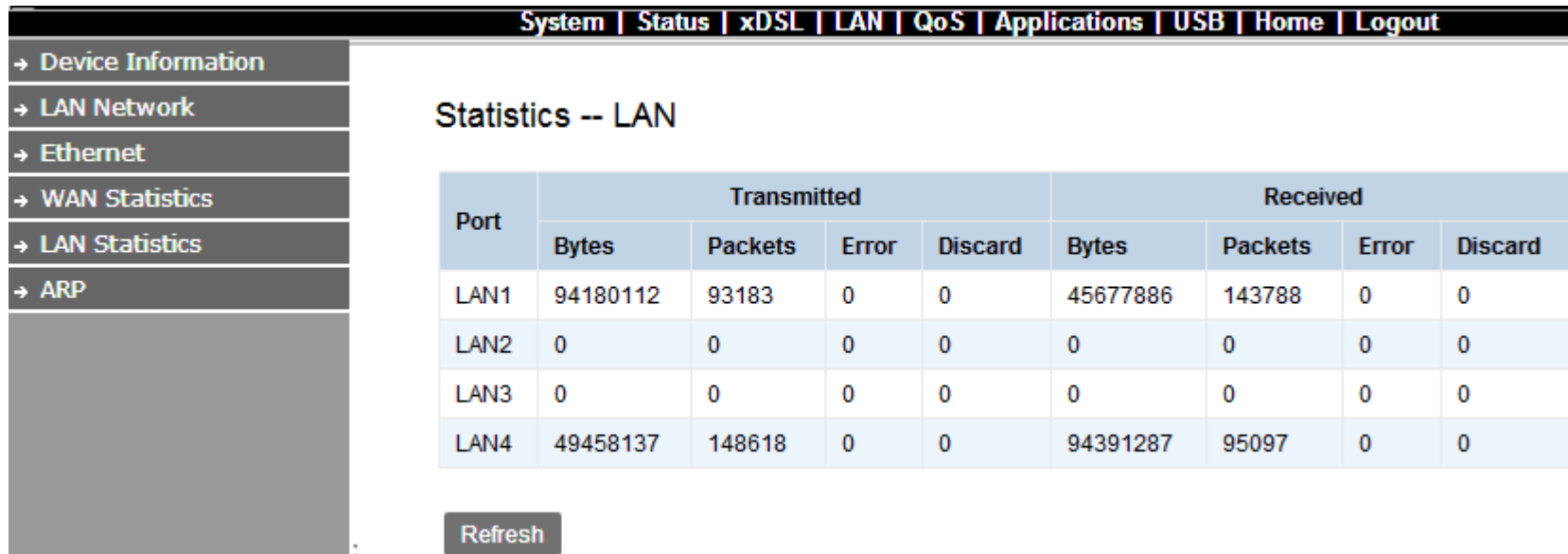

Figure 4.4.4 Statistics--LAN

4.4.5 ARP

Click on the “ARP” link in the left navigation bar, you will see the records of Flags, HW Address, and Device status for different IP addresses . A screen is displayed as shown in [Figure 4.4.5](#).

IP Address	Flags	HW Address	Device
192.168.16.1	Complete	00:50:7f:ce:f8:30	br0
192.168.16.26	Complete	ac:22:0b:8c:13:73	br0
192.168.16.3	Complete	10:c3:7b:46:06:8f	br0
192.168.16.15	Complete	88:d7:f6:54:fc:f6	br0

Figure 4.4.5 ARP setting

4.5 xDSL Setup

Select “xDSL”. It includes the sub-menus of **Dsl Status** 、 **Dsl Config**.

Click on the “Dsl Status” link in the left navigation bar, you will see VDSL Information for this device. A screen is displayed as shown in [Figure 4.5](#).

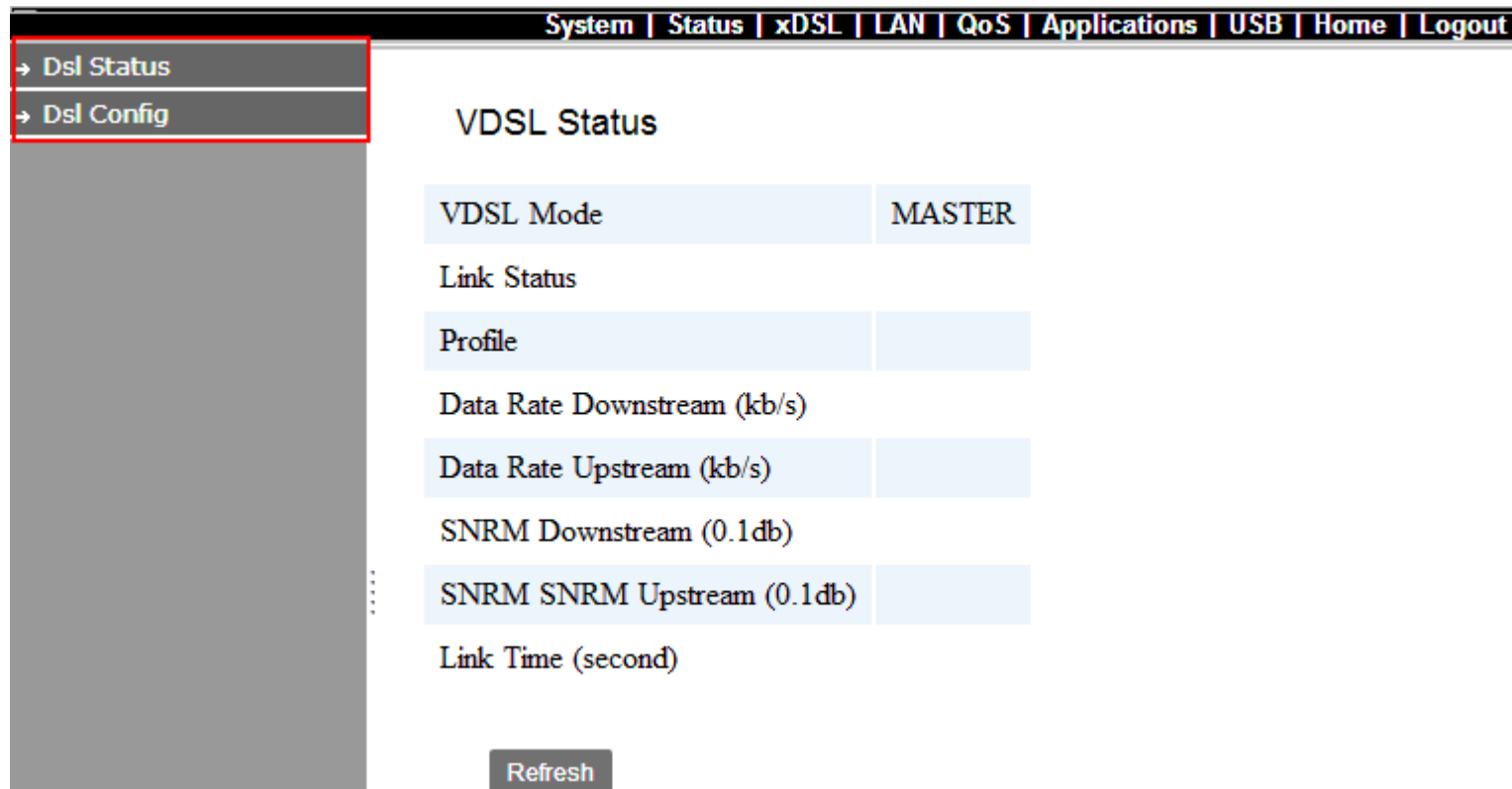

Figure 4.5. VDSL Information

4.5.1 Master/Slave mode & profile Config

Click on the “Dsl Config” link in the left navigation bar, there are 9 VDSL modes selectable, the default setting is “3. Master Mode, Sy-Auto 1_8/2 (SNRM 6/6)”. A screen is displayed as shown in [Figure 4.5.1](#).

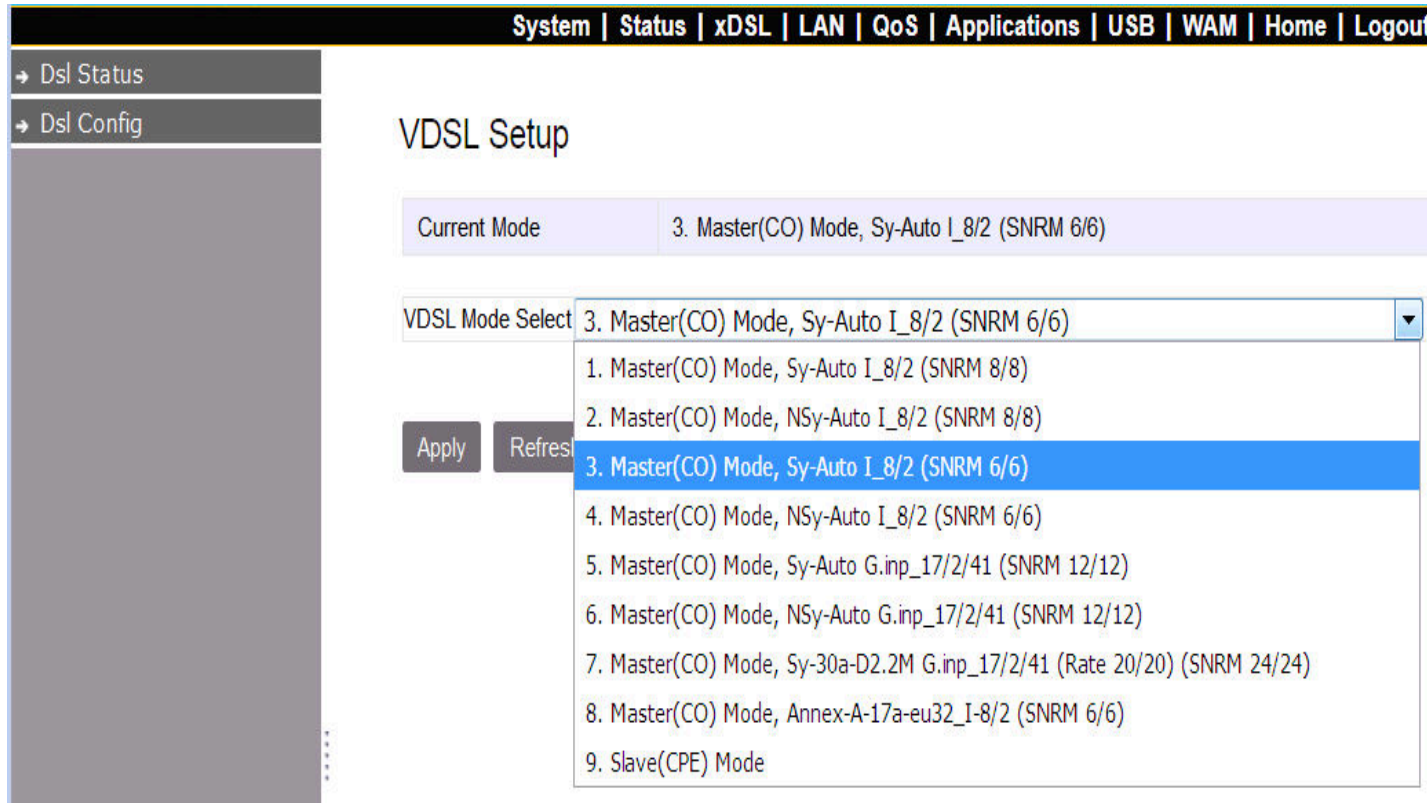

Figure 4.5.1 VDSL Setup

4.5.1.1 VDSL Config Overview

Below table clarify the settings of 9 different VDSL modes.

NO.	Config.	Note
1	Sy-Auto I_8/2 (SNRM 8/8)	Symmetric Auto, Max. Interleave=8, Min.Inp=2, SNRM=8
2	NSy-Auto I_8/2 (SNRM 8/8)	non symmetric Auto, Max. Interleave=8, Min.Inp=2, SNRM=8
3	Sy-Auto I_8/2 (SNRM 6/6)	Symmetric Auto, Max. Interleave=8, Min.Inp=2, SNRM=6 (Default)
4	NSy-Auto I_8/2 (SNRM 6/6)	Non symmetric Auto, Max. Interleave=8, Min.Inp=2, SNRM=6
5	Sy-Auto G.INP_17/2/41 (SNRM 12/12)	Symmetric Auto, enable G.INP, enable re-transmission, SNRM=12
6	NSy-Auto G.INP_17/2/41 (SNRM 12/12)	non symmetric Auto, enable G.INP, enable re-transmission, SNRM=12
7	Sy-30a-D2.2M G.INP_17/2/41 (Rate 20/20) (SNRM 24/24)	Symmetric 30a, disable 0~2.2MHz, enable G.INP, enable re-transmission, Max.Line rate=20Mbps, SNRM=24
8	Annex-A-17a-eu32_I-8/2 (SNRM 6/6)	17A Annex A Eu32, Max. Interleave=8, Min. Inp=2, SNRM=6

9	Slave Mode	Web config for Slave mode is available.
----------	-------------------	---

Note : This device is available to select Master (Config 1~8) / Slave (Config 9) mode through web config.

4.6 LAN Setup

Select “LAN”. It includes the sub-menus of IPv4 Configuration 、 IPv6 Configuration 、 IPv6Static Route 、 Ethernet Mode.

A screen is displayed as shown in [Figure 4.6](#).

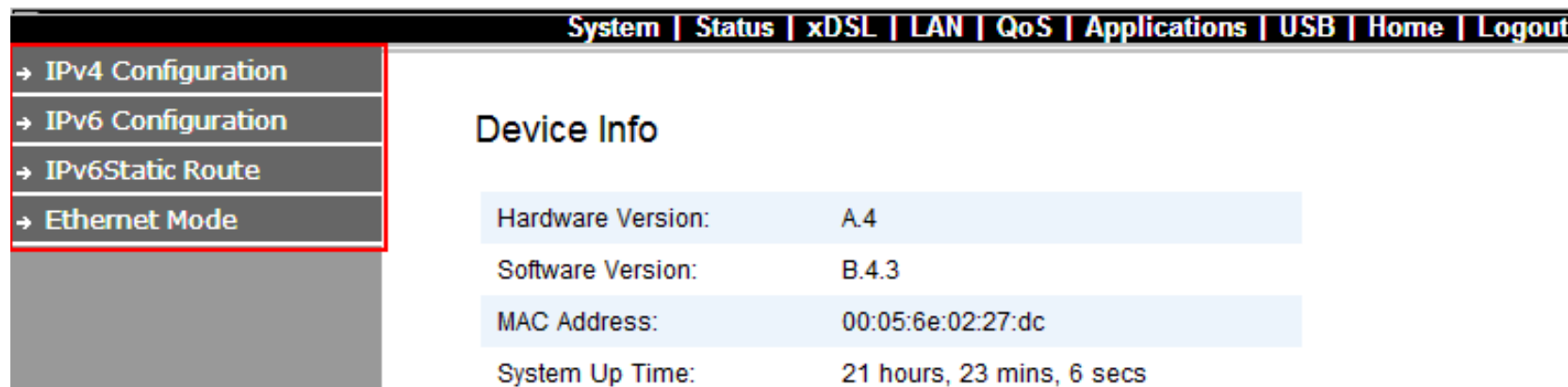
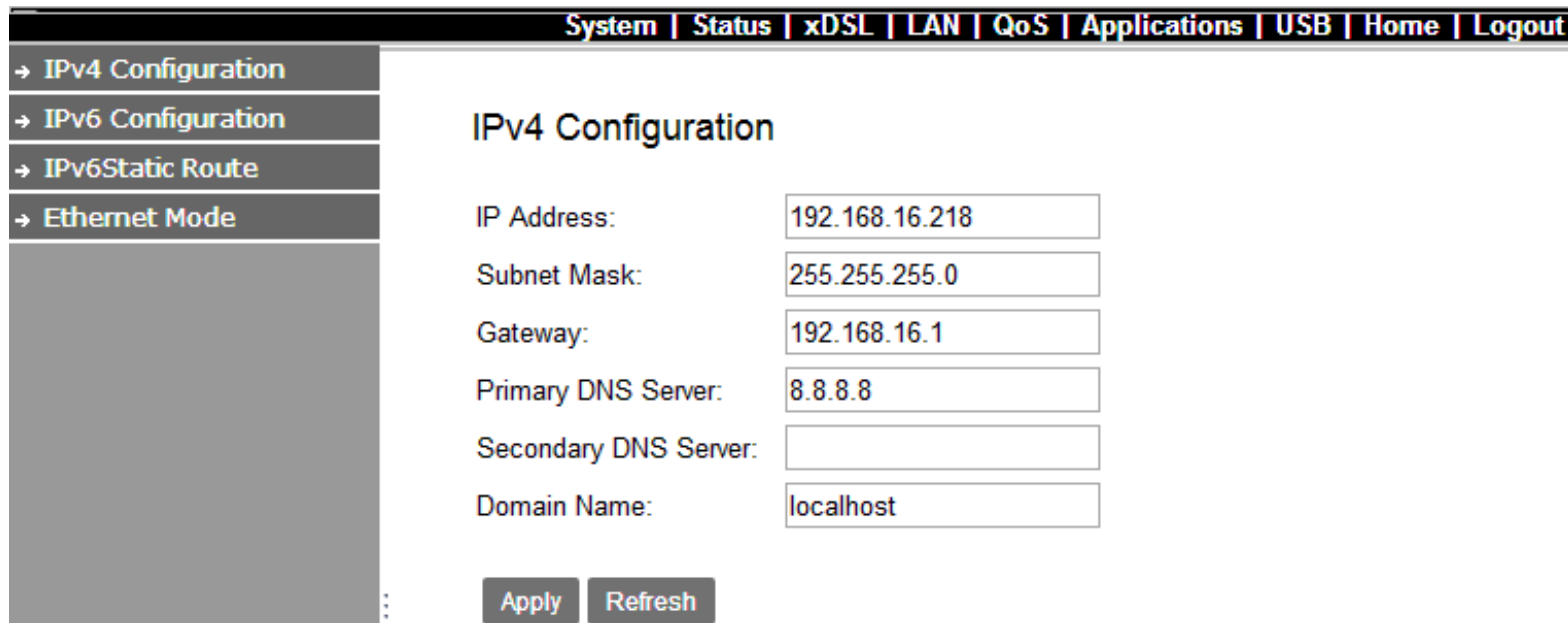

Figure 4.6 LAN

4.6.1 IPv4 Configuration

Click on the “IPv4 Configuration” link in the left navigation bar. Click “Apply” at any time during configuration to save the information that you have entered. A screen is displayed as shown in [Figure 4.6.1](#)



The screenshot shows a web interface for IPv4 Configuration. At the top, there is a navigation bar with links: System | Status | xDSL | LAN | QoS | Applications | USB | Home | Logout. On the left, a sidebar contains navigation links: → IPv4 Configuration (selected), → IPv6 Configuration, → IPv6Static Route, and → Ethernet Mode. The main content area is titled "IPv4 Configuration" and contains the following fields:

IP Address:	<input type="text" value="192.168.16.218"/>
Subnet Mask:	<input type="text" value="255.255.255.0"/>
Gateway:	<input type="text" value="192.168.16.1"/>
Primary DNS Server:	<input type="text" value="8.8.8.8"/>
Secondary DNS Server:	<input type="text"/>
Domain Name:	<input type="text" value="localhost"/>

At the bottom of the form, there are two buttons: "Apply" and "Refresh".

Figure 4.6.1 IPv4 Configuration

4.6.2 IPv6 Configuration:

Click on the “IPv6 Configuration” link in the left navigation bar. Click “Apply” at any time during configuration to save the information that you have entered. A screen is displayed as shown in [Figure 4.6.2](#)

System | Status | xDSL | LAN | QoS | Applications | USB | Home | Logout

→ IPv4 Configuration
 → IPv6 Configuration
 → IPv6Static Route
 → Ethernet Mode

IPv6 Configuration

IP Address: fe80::1

Min RA Interval:

Max RA Interval:

Server Mode: SLAAC Stateless DHCP Stateful DHCP

Primary DNS:

Prefix Mode: Static Derived From PD

Prefix:

Figure 4.6.2 IPv6 Configuration

4.6.3 IPv6Static Route

Click on the “IPv6Static Route” link in the left navigation bar. Click “add” to a new page and setup Static Route. A screen is displayed as shown in [Figure 4.6.3](#)

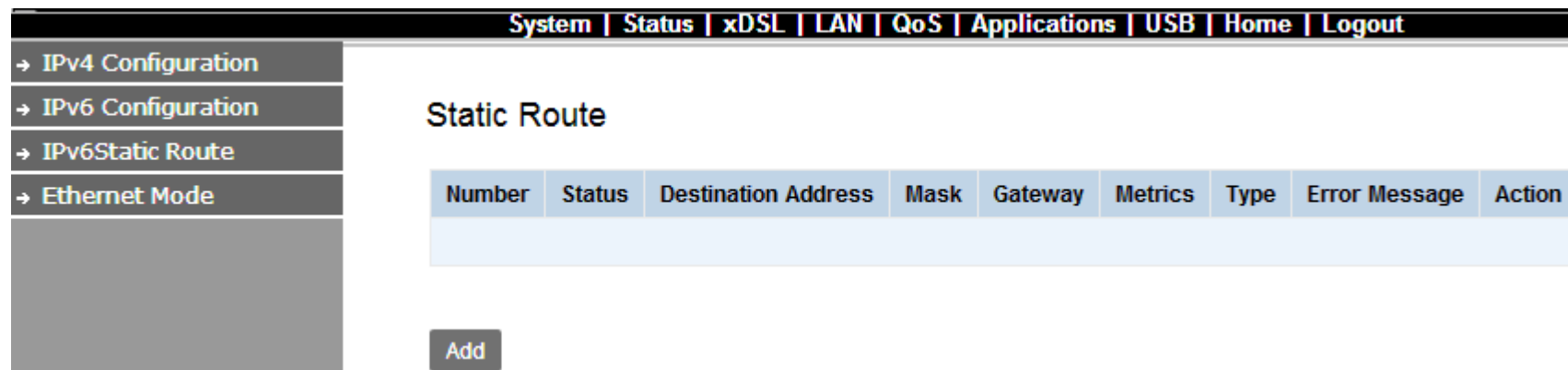

System | Status | xDSL | LAN | QoS | Applications | USB | Home | Logout

→ IPv4 Configuration
→ IPv6 Configuration
→ IPv6Static Route
→ Ethernet Mode

Static Route Setting

Connection Name:

Enable:

Destination Address:

Subnet Prefix Length:

Gateway:

Metrics:

Figure 4.6.3 IPv6Static Route

4.6.4 Ethernet Mode

Click on the “Ethernet Mode” link in the left navigation bar. Choose the speed (Auto, 10Mb/s, 100Mb/s) of LAN1~4, and click “Apply” to setup.

The screenshot displays the 'LAN - Ethernet Mode Configuration' page. At the top, there is a navigation bar with links: System | Status | xDSL | LAN | QoS | Applications | USB | Home | Logout. On the left, a sidebar menu includes: IPv4 Configuration, IPv6 Configuration, IPv6Static Route, and Ethernet Mode (which is highlighted). The main content area features a table with the following data:

Port	Status	Speed	Duplex
LAN1	Up	Auto ▼	Auto ▼
LAN2	Down	Auto ▼	Auto ▼
LAN3	Up	Auto ▼	Auto ▼
LAN4	Down	Auto ▼ Auto 10Mb/s 100Mb/s	Auto ▼

Below the table, there are two buttons: 'Apply' and 'Refresh'.

Figure 4.6.4 LAN-Ethernet Mode Configuration

4.7 Qos Setup

Select “Qos”. It includes the sub-menus of Qos Queue 、 Qos Classification. A screen is displayed as shown in [Figure 4.7](#).

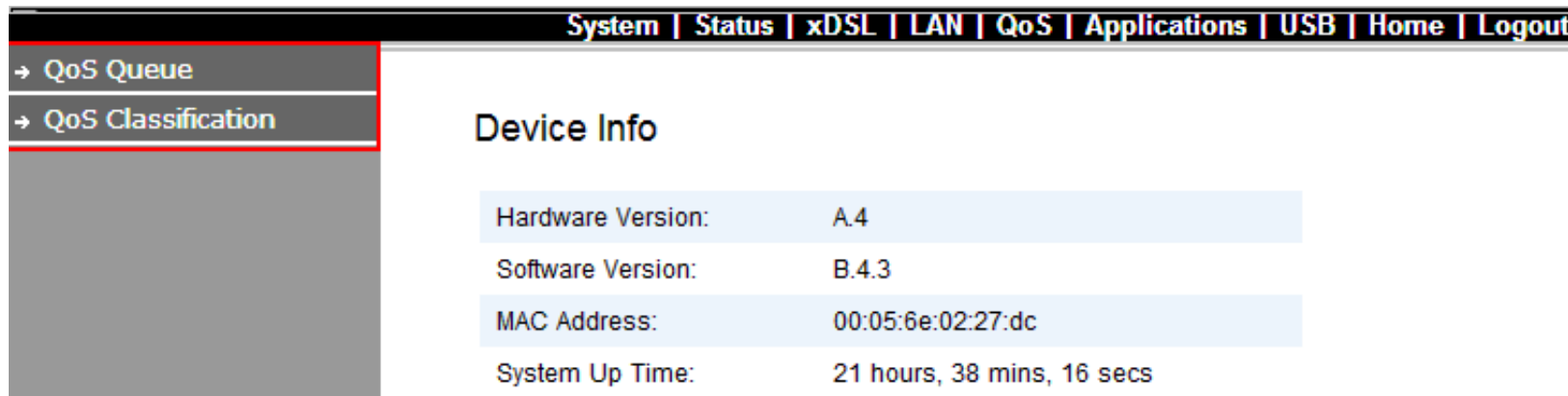

Figure 4.7 Qos

4.7.1 Qos Queue

Click on “Qos Queue” link in the left navigation bar, on the right page you will see how to enable Qos, and Upstream Queue Settings. There are four modes of Qos profiles. A screen is displayed as shown in [Figure 4.7.1](#).

System | Status | xDSL | LAN | QoS | Applications | USB | Home | Logout

→ QoS Queue
→ QoS Classification

QoS Global Settings

Enable QoS Profile: TR069,IPTV,INTERNET (Changing profile will affect all QoS settings)

Enable:

Upstream Bandwidth: kbps (0 means no rate limit)

Scheduling Policy: SP

Enable Force Bandwidth:

DSCP/TC Mark:

802.1P Tag:

TCP Connection Number Limit:

Upstream Queue Settings

Number	Enable	Priority(1 is the highest)
1	<input type="checkbox"/>	1
2	<input type="checkbox"/>	2
3	<input type="checkbox"/>	3
4	<input type="checkbox"/>	4
5	<input type="checkbox"/>	5
6	<input type="checkbox"/>	6
7	<input type="checkbox"/>	7
8	<input type="checkbox"/>	8

Apply Refresh

Figure 4.7.1 Qos Global Settings

4.8 Applications

Select “Applications”. It includes the sub-menus of Telnet Service、SSH Service、Printer Share、Multimedia Share、UPnP、Multicast IGMP、Multicast MLD、SNMP. A screen is displayed as shown in [Figure 4.8](#).

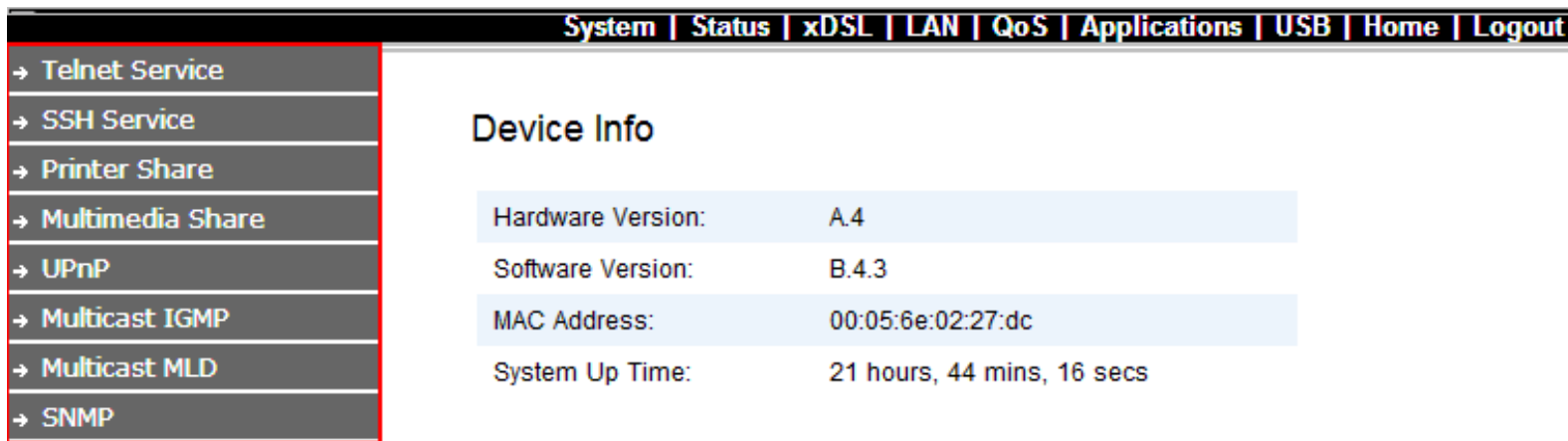

Figure 4.8 Applications

4.8.1 Telnet Service Setup(for Security)

Click on “Telnet Service” link in the left navigation bar, on the right page you will see how to enable Telnet Service. A screen is displayed as shown in [Figure 4.8.1](#)

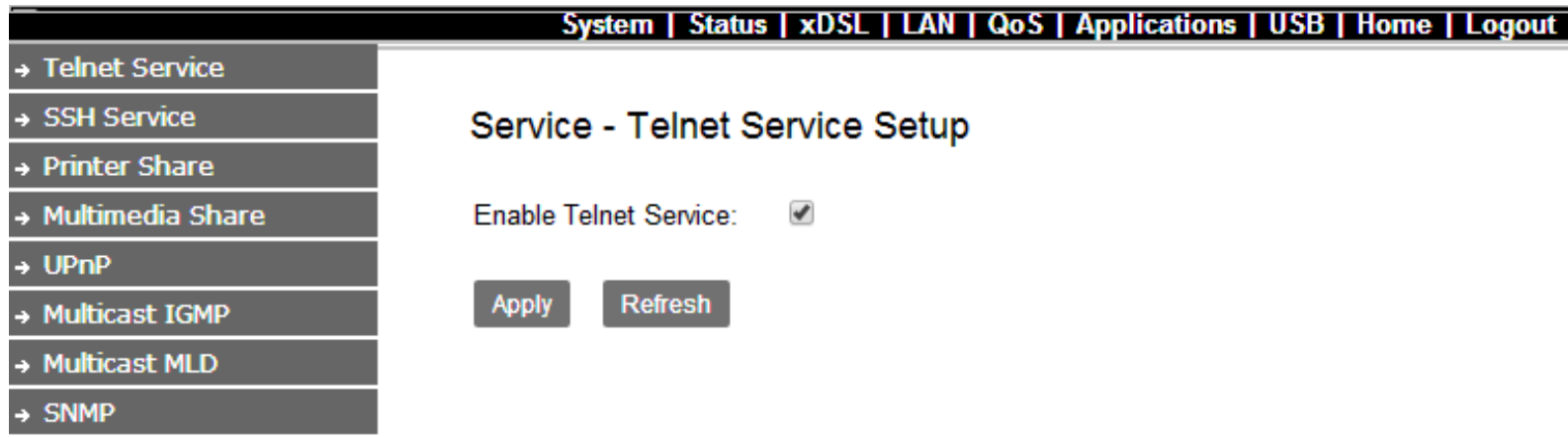

Figure 4.8.1 Service-Telnet Service Setup

4.8.2 SSH Service(Telnet Encryption)

Click on “SSH Service” link in the left navigation bar, on the right page you will see how to enable SSH Service. A screen is displayed as shown in [Figure 4.8.2](#)

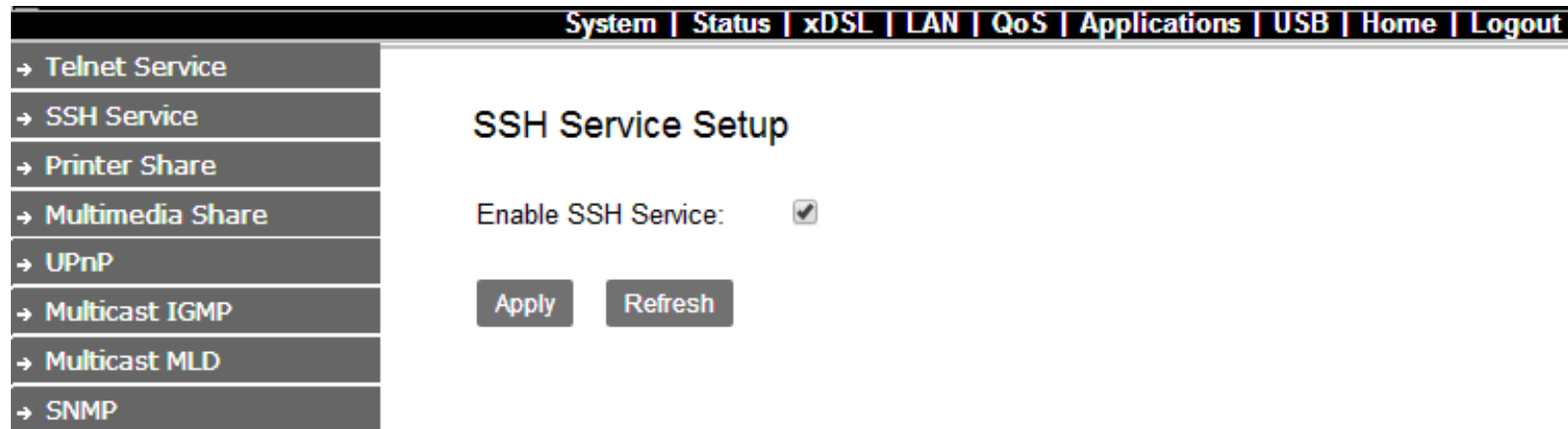

Figure 4.8.2 SSH Service Setup

4.8.3 Printer Sharing

Click on “Printer Share” link in the left navigation bar, on the right page you will see how to enable Printer Service, and type Queue Name. A screen is displayed as shown in [Figure 4.8.3](#).

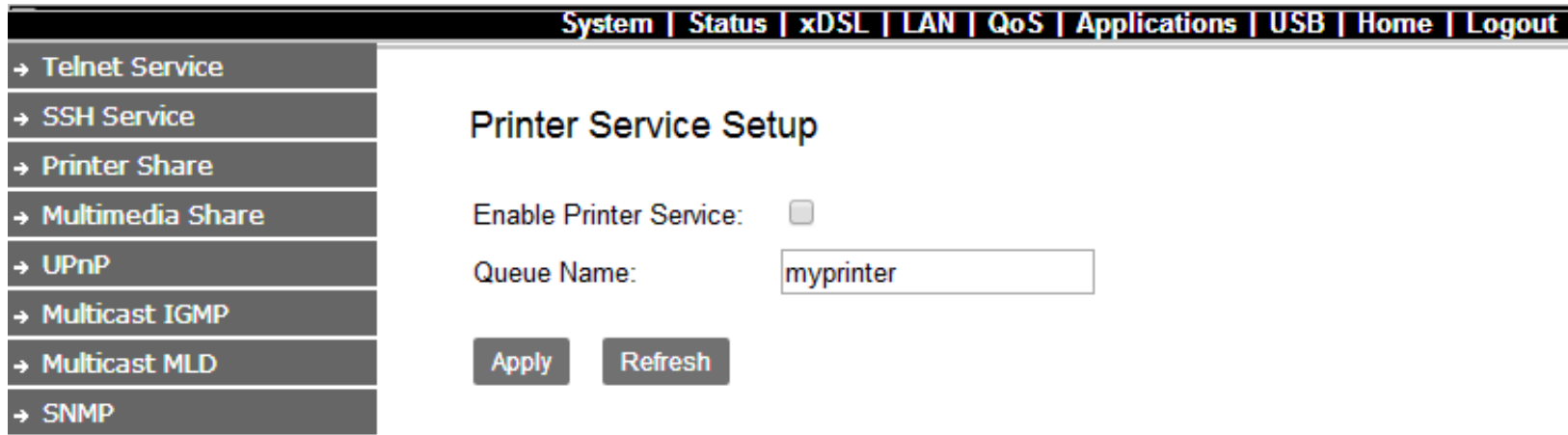

Figure 4.8.3 Printer Service Setup

4.8.4 Multimedia Sharing

Click on “Multimedia Share” link in the left navigation bar, on the right page you will see how to enable DMS, and select Share Folders. A screen is displayed as shown in [Figure 4.8.4](#).

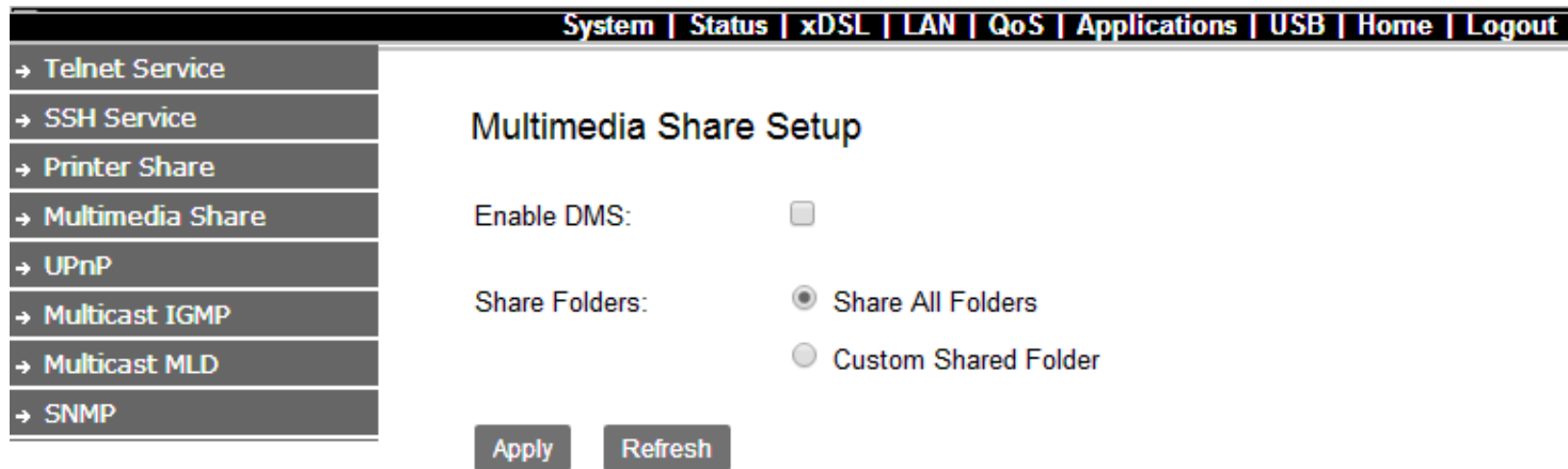

Figure 4.8.4 Multimedia Share Setup

4.8.5 UPnP

Click on “UPnP” link in the left navigation bar, on the right page you will see how to enable UPnP, and add Blacklist. A screen is displayed as shown in [Figure 4.8.5](#).

System | Status | xDSL | LAN | QoS | Applications | USB | Home | Logout

- Telnet Service
- SSH Service
- Printer Share
- Multimedia Share
- **UPnP**
- Multicast IGMP
- Multicast MLD
- SNMP

UPnP

Enable UPnP IGD:

WAN Connection:

Blacklist

Enable:

IP Address:

Enable	Number	IP Address	Action
No Rule Found!			

Figure 4.8.5 UPnP

4.8.6 Multicast IGMP

Click on “Multicast IGMP” link in the left navigation bar. According to the setting, if you want to test IGMP function, you only need to enable IGMP function basic on the Application setup.

The screenshot displays the 'IGMP Settings' configuration page. At the top, there is a navigation bar with links: System, Status, xDSL, LAN, QoS, Applications, USB, Home, and Logout. On the left, a vertical navigation menu lists various services: Telnet Service, SSH Service, Printer Share, Multimedia Share, UPnP, Multicast IGMP (highlighted), Multicast MLD, and SNMP. The main content area is titled 'IGMP Settings' and includes the following configuration options:

- Default Version:** A dropdown menu currently showing 'IGMP v2', with 'IGMP v3' also visible in the list.
- Query Interval(s):** A text input field.
- Query Response Interval(1/10s):** A text input field containing the value '100'.
- Last Member Query Interval(1/10s):** A text input field containing the value '10'.
- Robustness Value:** A text input field containing the value '2'.
- Maximum Multicast Data Source(for IGMPv3):** A text input field containing the value '10'.
- Fast Leave Enable:** A checked checkbox.
- Membership Join Immediate(IPTV):** An unchecked checkbox.

Below these settings are two sets of 'Apply' and 'Refresh' buttons. The first set is located below the main configuration fields, and the second set is located below the 'Enable IGMP Snooping' checkbox, which is currently checked.

Figure 4.8.6 IGMP Settings

4.8.7 Multicast MLD (IPv6)

Click on “Multicast MLD” link in the left navigation bar. According to the setting, if you want to test MLD function, you only need to enable MLD function basic on the Application setup.

The screenshot displays the MLD Settings configuration page. At the top, there is a navigation bar with links: System, Status, xDSL, LAN, QoS, Applications, USB, Home, and Logout. On the left, a vertical navigation menu lists various services: Telnet Service, SSH Service, Printer Share, Multimedia Share, UPnP, Multicast IGMP, Multicast MLD (highlighted), and SNMP. The main content area is titled "MLD Settings" and includes a blue instruction: "Enter MLD protocol(IPv6 Multicast)configure fields if you want modify default values shown below." The configuration fields are as follows:

- Default Version: A dropdown menu set to "MLD v2".
- Query Interval(s): An input field.
- Query Response Interval(1/10s): An input field with the value "100".
- Last Member Query Interval(1/10s): An input field with the value "10".
- Robustness Value: An input field with the value "2".
- Maximum Multicast Data Source(for mldv2): An input field with the value "10".
- Fast Leave Enable: A checked checkbox.

Below these fields are two sets of "Apply" and "Refresh" buttons. The second set is preceded by the "Enable MLD Snooping:" checkbox, which is also checked.

Figure 4.8.7 MLD Settings

4.8.8 SNMP

Click on “SNMP” link in the left navigation bar, on the right page you will see how to enable SNMP function. NV-700L supports SNMP V1/V2.

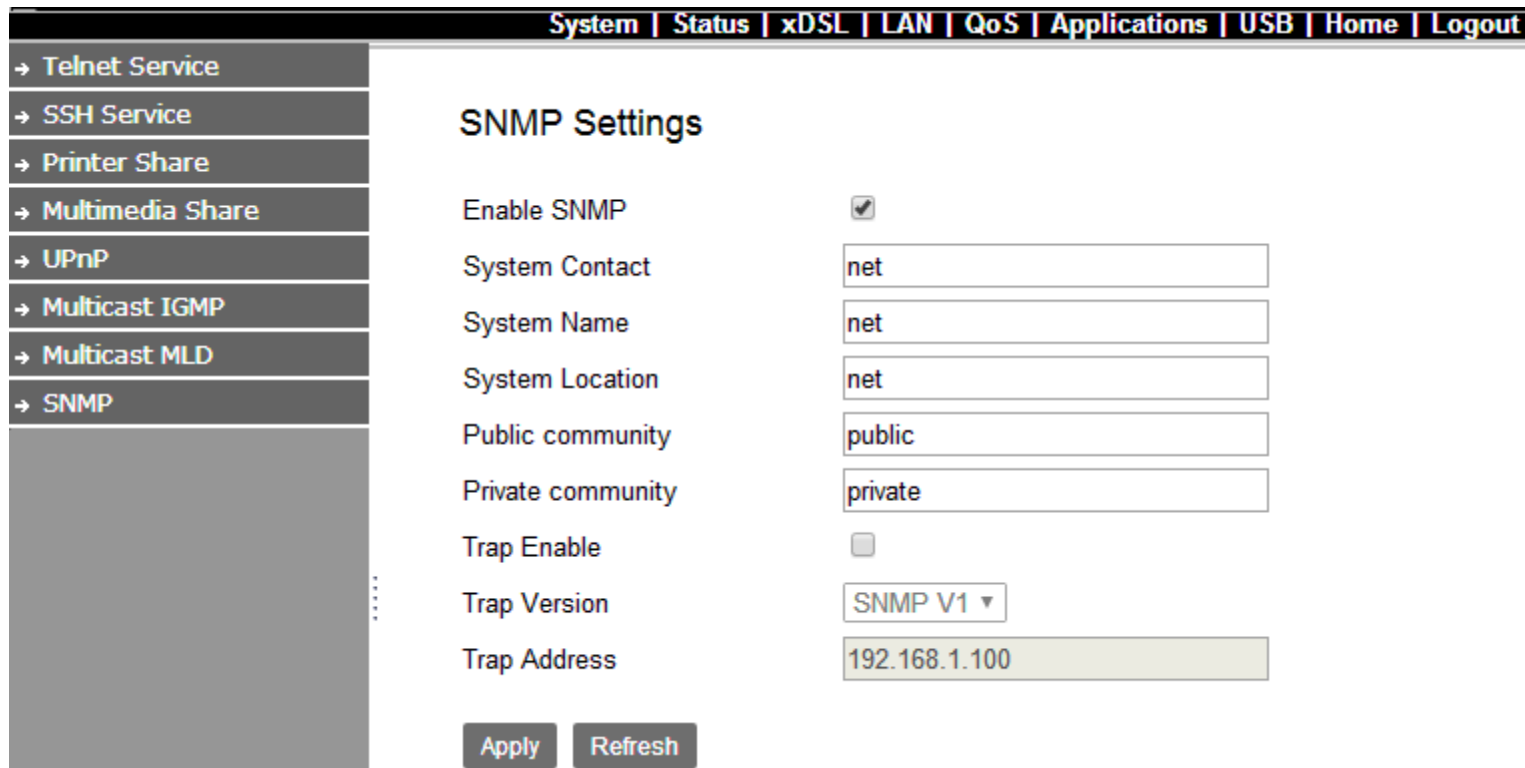

System Status xDSL LAN QoS Applications USB Home Logout	
→ Telnet Service	
→ SSH Service	
→ Printer Share	
→ Multimedia Share	
→ UPnP	
→ Multicast IGMP	
→ Multicast MLD	
→ SNMP	

SNMP Settings

Enable SNMP	<input checked="" type="checkbox"/>
System Contact	<input type="text" value="net"/>
System Name	<input type="text" value="net"/>
System Location	<input type="text" value="net"/>
Public community	<input type="text" value="public"/>
Private community	<input type="text" value="private"/>
Trap Enable	<input type="checkbox"/>
Trap Version	<input type="text" value="SNMP V1"/>
Trap Address	<input type="text" value="192.168.1.100"/>

Figure 4.8.8 SNMP Settings

Download “MG-SOFT MIB Browser”. Below picture indicate how to use the software, and connect remote SNMP agent.

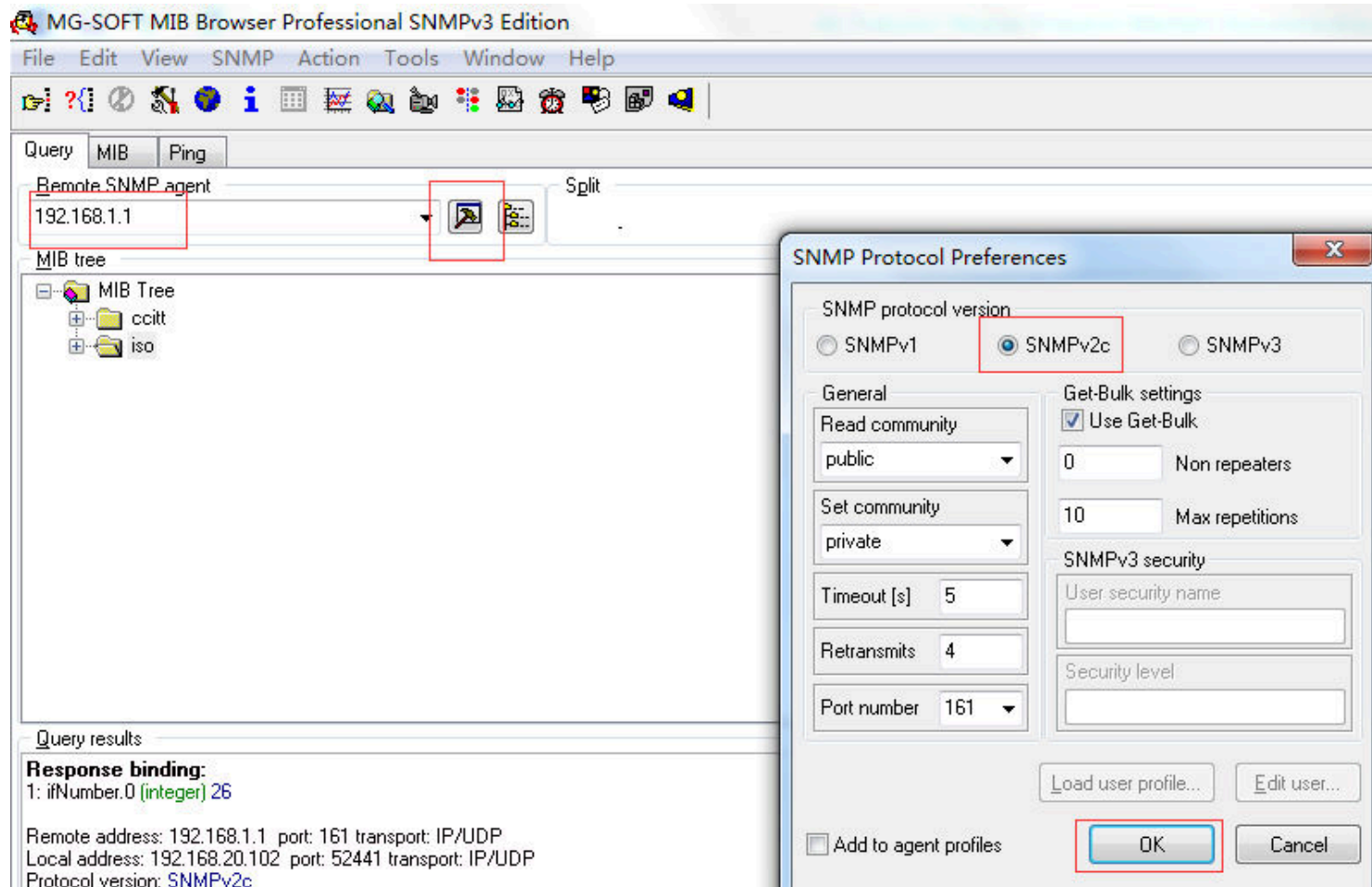

Select OID:1.3.6.1.2.1.1.3

SysUp Time

The screenshot shows a network management interface with the following components:

- Query** tab selected, with sub-tabs for **MIB** and **Ping**.
- Remote SNMP agent** dropdown menu set to **192.168.1.1**.
- MIB tree** view showing a hierarchical structure: **MIB Tree** > **iso** > **org** > **dod** > **internet** > **mgmt** > **mib-2** > **system**. The **sysUpTime** node is highlighted with a red box.
- Query results** section showing the following text:

```
***** SNMP QUERY STARTED *****  
1: sysUpTimeInstance (timeticks) 0 days 16h:52m:37s.13th (6075713)  
***** SNMP QUERY FINISHED *****  
  
Remote address: 192.168.1.1 port: 161 transport: IP/UDP  
Local address: 192.168.20.102 port: 64685 transport: IP/UDP  
Protocol version: SNMPv2c  
1: sysUpTimeInstance (timeticks) 0 days 16h:53m:09s.53th (6078953)
```

The final line of the query results is also highlighted with a red box.

4.9 USB setup

Select “USB”. It includes the sub-menus of Storage Device Info、Samba Server、FTP Server、FTP Client、TFTP Server.

A screen is displayed as shown in [Figure 4.9](#).

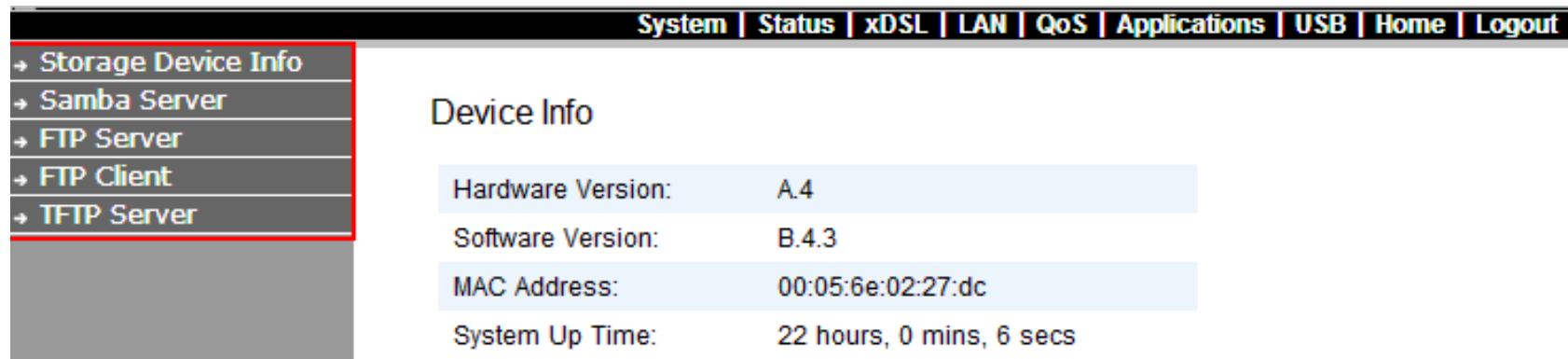

Figure 4.9 USB

4.9.1 Storage Device Info

Insert a U disk into the USB interface, then login 192.168.16.249, click on “Storage Device Info” link in the left navigation bar. Confirm the system has mounted the U disk. A screen is displayed as shown in [Figure 4.9.1](#)

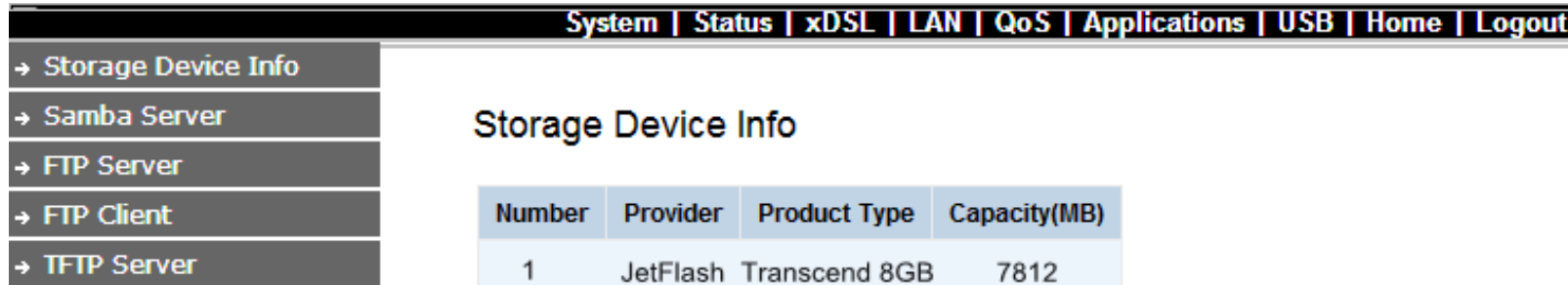

Figure 4.9.1 Storage Device Info

4.9.2 Samba Service

Click on “Samba Service” link in the left navigation bar, on the right page you will see how to enable Samba Service. A screen is displayed as shown in [Figure 4.9.2](#).

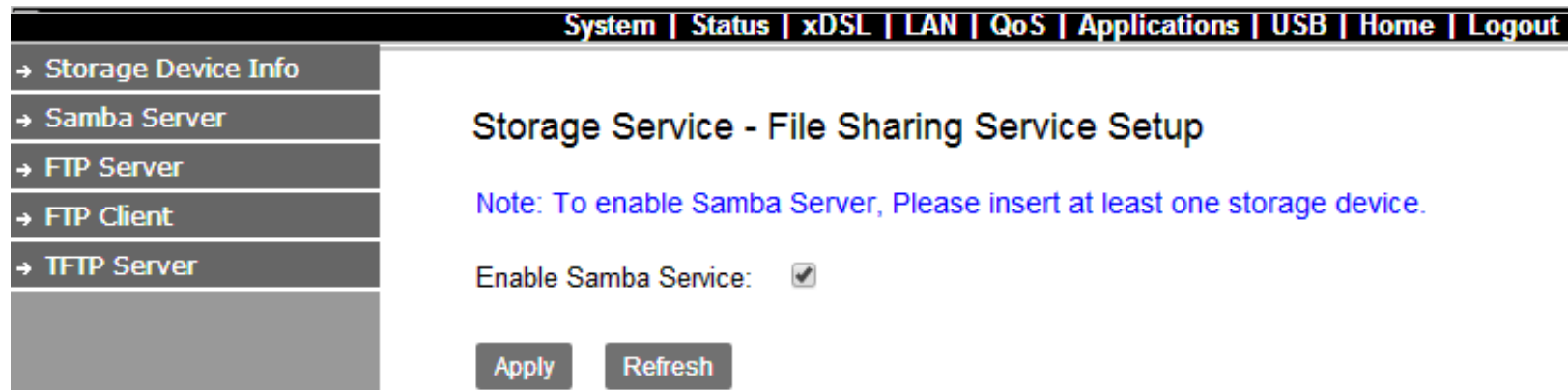

Figure 4.9.2 File Sharing Service Setup

Note: To enable Samba Service, please insert at least one storage device.

4.9.3 FTP Server

Click on “FTP Server” link in the left navigation bar, on the right page you will see how to enable FTP Service function. A screen is displayed as shown in [Figure 4.9.3](#).

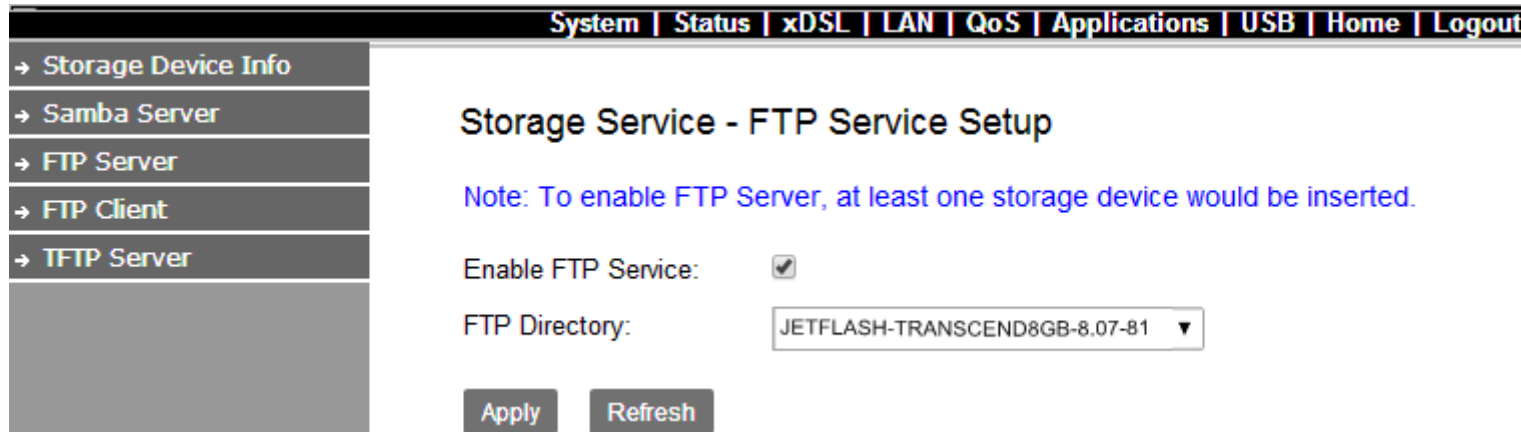

Figure 4.9.3 FTP Service Setup

Note: To enable FTP Server, at least one storage device would be inserted.

4.9.4 FTP Client

Click on “FTP Client” link in the left navigation bar, on the right page you can input FTP Client Settings, and click “Download”. A screen is displayed as shown in [Figure 4.9.4](#).

System | Status | xDSL | LAN | QoS | Applications | USB | Home | Logout

→ Storage Device Info
→ Samba Server
→ FTP Server
→ **FTP Client**
→ TFTP Server

Storage Service - FTP Client Settings

User Name:

Password:

Download URL:

Port:

Device:

Save Path:

Download

The latest 10 download records

Refresh

User Name	Password	Port	Download URL	Save Path	Progress	Status	Action
blake		21	ftp://netsys.com.tw/hello.htm	xdown	100%	complete	Delete

System | Status | xDSL | LAN | QoS | Applications | USB | Home | Logout

- Storage Device Info
- Samba Server
- FTP Server
- FTP Client
- TFTP Server

Storage Service - FTP Client Settings

User Name:

Password:

Download URL:

Port:

Device:

Save Path:

The latest 10 download records

User Name	Password	Port	Download URL	Save Path	Progress	Status	Action
blake		21	<input type="text" value="ftp://netsys.com.tw/hello.htm"/>	xdown	100%	complete	<input type="button" value="Delete"/>

Figure 4.9.4 FTP Client Settings

Click “Refresh”, and make sure the status is complete.

The latest 10 download records



User Name	Password	Port	Download URL	Save Path	Progress	Status	Action
blake		21	ftp://netsys.com.tw/hello.htm	xdown	100%	Complete	Delete

Figure 4.9.4 FTP Client Settings

4.9.5 TFTP Server

Click on “TFTP Server” link in the left navigation bar, on the right page you will see how to enable TFTP Server function. A screen is displayed as shown in [Figure 4.9.5](#).

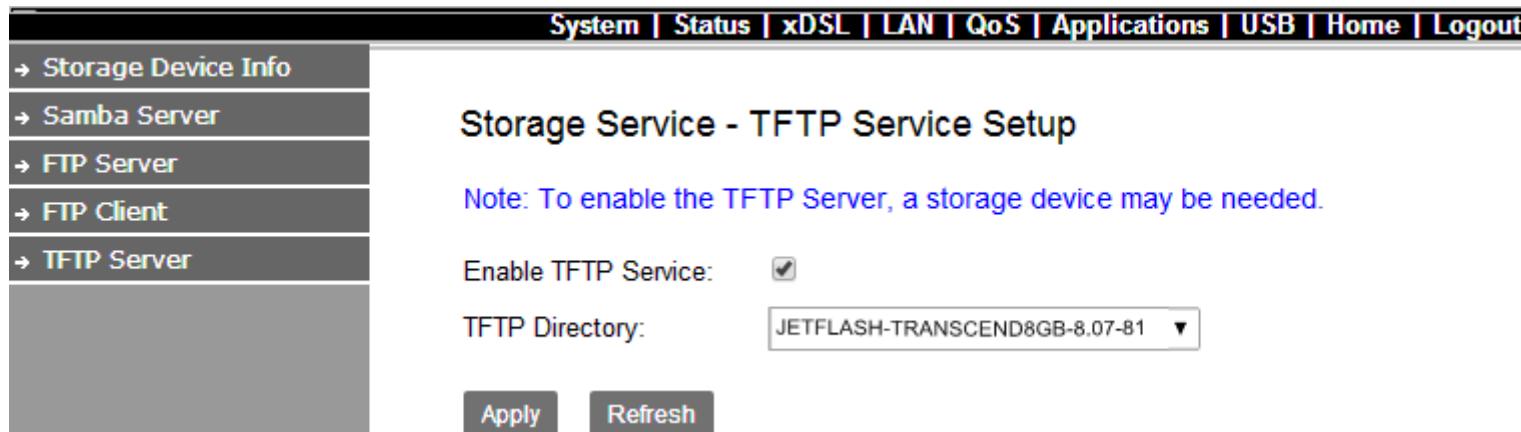

Figure 4.9.5 TFTP Service Setup

Appendix A: Cable Requirements

A.1 Ethernet Cable

A CAT 3~7 UTP (unshielded twisted pair) cable is typically used to connect the Ethernet device to the Modem. A 10Base-T cable often consists of four pairs of wires, two of which are used for transmission. The connector at the end of the 10Base-T cable is referred to as an RJ-45 connector and it consists of eight pins. The Ethernet standard uses pins 1, 2, 3 and 6 for data transmission purposes. (Table A-1)

Table A-1 RJ-45 Ethernet Connector Pin Assignments

PIN #	MDI		MDI-X	
	Signal	Media Dependant interface	Signal	Media Dependant interface-cross
1	TX+	Transmit Data +	RX+	Receive Data +
2	TX-	Transmit Data -	RX-	Receive Data -
3	RX+	Receive Data +	TX+	Transmit Data +
4	--	Unused	--	Unused
5	--	Unused	--	Unused
6	RX-	Receive Data -	TX-	Transmit Data -
7	--	Unused	--	Unused
8	--	Unused	--	Unused

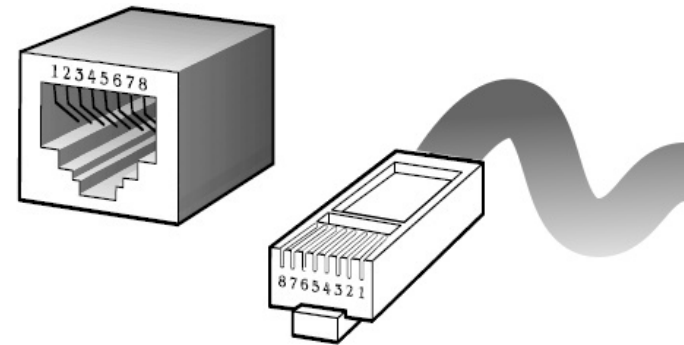

Figure A-1 Standard RJ-45 repectacle/connector

Note:

Please make sure your connected cables have the same pin assignment as the table above before deploying the cables into your network.

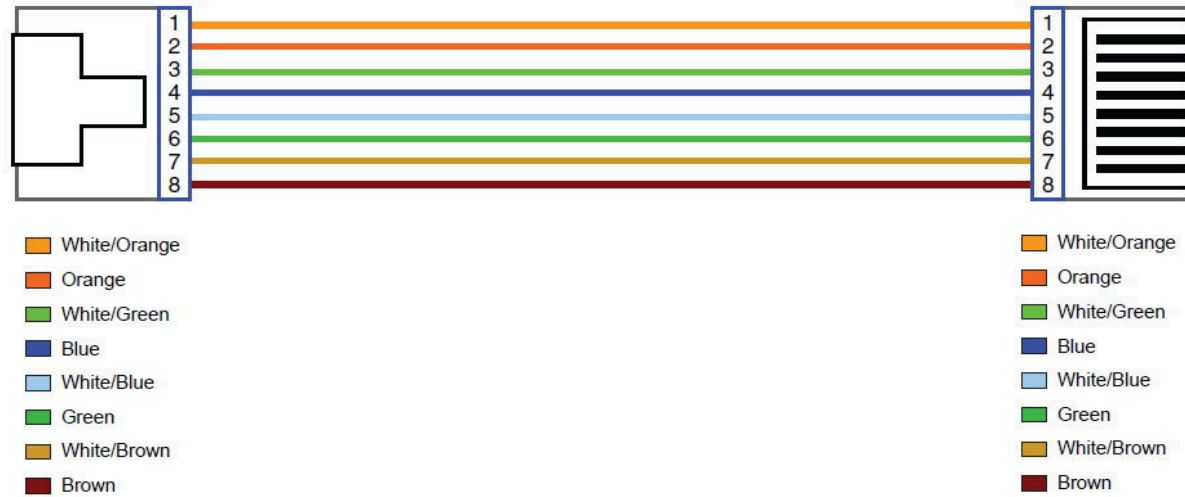

Figure A-2 Pin Assignments and Wiring for an RJ-45 Straight-Through Cable

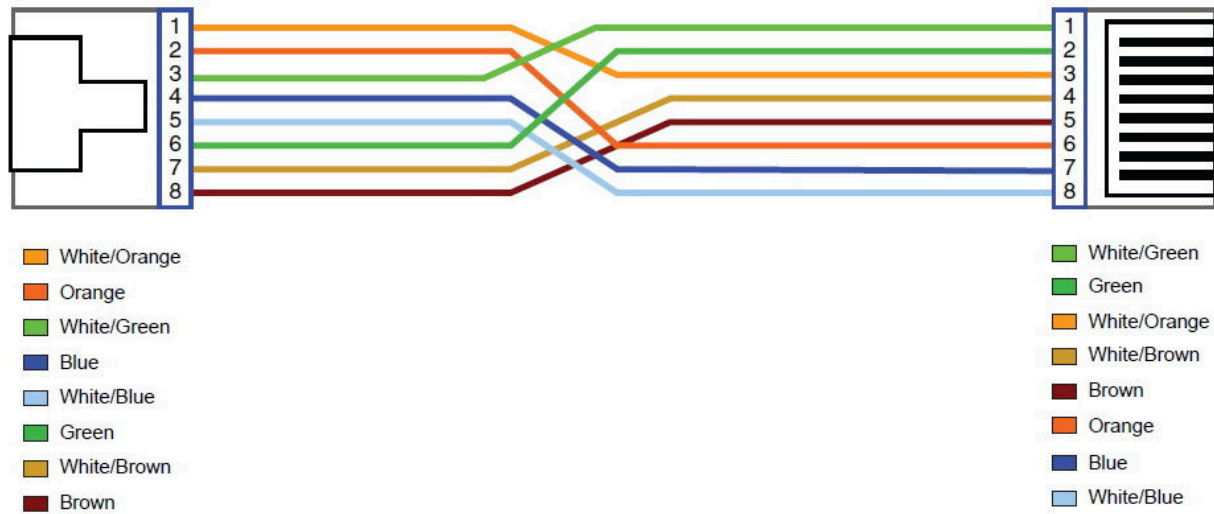

Figure A-3 Pin Assignments and Wiring for an RJ-45 Crossover Cable

A.2 Telephone wire

Standard telephone wire of any gauge or type-flat, twisted or quad is used to connect the Modem to the telephone network. A telephone cable typically consists of three pairs of wires, one of which is used for transmission. The connector at the end of the telephone cable is called an RJ-11 connector and it consists of six pins. POTS (plain old telephone services) use pins 3 and 4 for voice transmission. A telephone cable is shown below. (Figure A-4)

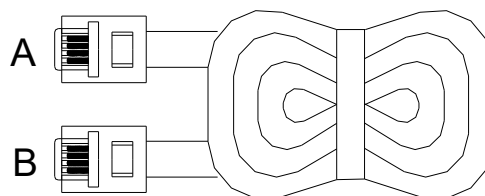

Figure A-4 Telephone cable

The A and B connectors on the rear of the Modem are RJ-11 connectors. These connectors are wired identically. The RJ-11 connectors have six positions, two of which are wired. The Modem uses the center two pins. The pin out assignment for these connectors is presented below. (Table A-2)

Table A-2 RJ-11 Pin out Assignments

Pin#	MNEMONIC	FUNCTION
1	NC	Unused
2	NC	Unused
3	TIP	POTS
4	RING	POTS
5	NC	Unused
6	NC	Unused

Appendix B: Product Specification

Key Features & Benefits

- ◆ Adopts ARM Cortex A9 dual-core processor
- ◆ Supports Master/Slave Mode selectable by Web config menu
- ◆ Supports G.998.4 G.INP
- ◆ Supports up to 100 Mbps symmetric
- ◆ Support 8 bands selectable
- ◆ Support USB 2.0 for connecting USB Dongle
- ◆ Supports IPv4/IPv6 NTP Client
- ◆ Support static routing for IPv4 and IPv6 forwarding
- ◆ Mac Address based filtering
- ◆ Http/https Web-based management
- ◆ Support IGMP snooping v2/v3
- ◆ Compliant with IEEE 802.3 & 802.3u Ethernet Standard
- ◆ Support VLAN Tag pass through
- ◆ Compliant with ITU-T G993.2 VDSL2 standard
- ◆ Support 8 queue MFC/DSCP both type QoS
- ◆ Supports HTTP/HTTPS web management
- ◆ Support SSL / SSH security
- ◆ Support remote management and monitor
- ◆ Support configuration backup and restore
- ◆ On board surge protection for Line port

- ◆ Supports bridge mode only
- ◆ Supports Dual Firmware Image Backup
- ◆ Supports SNMP v1/v2
- ◆ On board POTS/ISDN splitter
- ◆ Supports TR-069
- ◆ Supports Jumbo frame(MTU) up to 2k bytes

Note:

1. Features and specifications in this manual are subject to change without prior notice.
2. (*) Firmware upgradeable for future enhancement.

Product Specification

Standard:	IEEE802.3/802.3u standards ITU-T G993.2/G998.4 standards
Regulatory Compliance:	FCC CE RoHS Compliance
Physical Interface:	4 x RJ-45 10/100 Mbps Ethernet port 1 x RJ-11 / Terminal combo for line port 1 x RJ-11 connector for POTS/ISDN phone device 1 x Reset Button for resetting to factory default 1 x USB2.0 for connecting USB dongle
LED Indicators:	1 x Power LED 4 x Link/Active Status for Ethernet port 1 x Link LED for VDSL2 port 1 x USB LED 1 x CO(Master) LED
Switch method:	Store and forward
Flow control:	Full duplex: IEEE 802.3x Half duplex: Back pressure
Typical Power Consumption:	4.4W (Full load, without USB port)

Power Supply:	Input Voltage: 12 VDC (Commerical-grade power adapter)
Operating Temperature:	0°C ~ 50°C (32°F ~ 122°F) Fanless, free air cooling
Storage Temperature:	-20°C ~ 70°C (-4°F ~158°F)
Humidity:	10% to 90% (non-condensing)
Dimensions:	184 x 146 x 40 mm (7.2" x 5.74" x 1.57")
Weight:	0.4 kg
EMC Certification:	EMI Compliant: FCC EMS Compliant: CE mark

Appendix C: Troubleshooting

Diagnosing the Modem's Indicators

The modem can be easily monitored through its comprehensive panel indicators. These indicators assist the network manager in identifying problems the hub may encounter. This section describes common problems you may encounter and possible solutions.

1. Symptom:	POWER indicator does not light up (green) after power on.
Cause:	Defective External power supply
Solution:	Check the power plug by plugging in another that is functioning properly. Check the power cord with another device. Check the terminal block make sure to fasten the power cord. If these measures fail to resolve the problem, have the unit power supply replaced by a qualified distributor.
Note:	Please refer to power status table to check power input status. Section 3.3
2. Symptom:	Link indicator does not light up (green) after making a connection.
Cause:	Network interface (ex. a network adapter card on the attached device), network cable, or switch port is defective.
Solution:	2.1 Verify that the switch and attached device are power on. 2.2 Be sure the cable is plugged into both the switch and corresponding device. 2.3 Verify that the proper cable type is used and its length does not exceed specified limits. 2.4 Check the modem on the attached device and cable connections for possible defects. 2.5 Make sure that the phone wire must be connecting NV-700L first, when powered on.

	<p>2.6 Replace the defective modem or cable if necessary.</p> <p>2.7 Or try to change band profile as 17a for getting long reach</p>
--	--

3. Symptom:	Line Link cannot be established.
Cause:	NV-700L Master/Slave setting failure or phone cable length is over the specification limit.
Solution:	<p>3.1 Please make sure that the phone wire must be connected between NV-700L(Master) side and NV-700L(Slave) side when both are power on. NV-700L Master side will do link speed function depending on phone wire length, therefore if NV-700L Master side can't detect Slave Side over phone wire while both power on, this will cause the Link to fail.</p> <p>3.2 Please check phone wire, we recommend use 24-26 gauge with twisted pair and without rust.</p> <p>3.3 Please reinsert power when change cable length or link time over 3 minutes.</p> <p>3.4 Or try to change band profile as 17a for getting long reach.</p>
Note:	Phone wire must meet CAT 3 standard or above and twisted pair, otherwise will cause more cross talk issue to reduce Line power driver.

4. Question:	What is VDSL2 technology? (Only reference)
Answer:	<p>Very-high-speed digital subscriber line 2 (VDSL2) is an access technology that exploits the existing infrastructure of copper wires that were originally deployed for traditional telephone service. It can be deployed from central offices, from fiber-optic connected cabinets located near the customer premises, or within buildings. It was defined in standard ITU-T G.993.2 finalized in 2005.</p> <p>VDSL2 was the newest and most advanced standard of digital subscriber line (DSL) broadband wireline communications. Designed to support the wide deployment of triple play services such as voice, video, data, high definition television (HDTV) and interactive gaming, VDSL2 was intended to</p>

enable operators and carriers to gradually, flexibly, and cost-efficiently upgrade existing xDSL infrastructure.

The protocol was standardized in the International Telecommunication Union telecommunications sector (ITU-T) as Recommendation G.993.2. It was announced as finalized on 27 May 2005,[1] and first published on 17 February 2006. Several corrections and amendments were published in 2007 through 2011.

VDSL2 is an enhancement to very-high-bitrate digital subscriber line (VDSL), Recommendation G.993.1. It permits the transmission of asymmetric and symmetric aggregate data rates up to 200 Mbit/s downstream and upstream on twisted pairs using a bandwidth up to 30 MHz.

VDSL2 deteriorates quickly from a theoretical maximum of 250 Mbit/s at source to 100 Mbit/s at 0.5 km (1,600 ft) and 50 Mbit/s at 1 km (3,300 ft), but degrades at a much slower rate from there, and still outperforms VDSL. Starting from 1.6 km (1 mi) its performance is equal to ADSL2+.

ADSL-like long reach performance is one of the key advantages of VDSL2. LR-VDSL2 enabled systems are capable of supporting speeds of around 1–4 Mbit/s (downstream) over distances of 4–5 km (2.5–3 miles), gradually increasing the bit rate up to symmetric 100 Mbit/s as loop-length shortens. This means that VDSL2-based systems, unlike VDSL1 systems, are not limited to short local loops or MTU/MDUs only, but can also be used for medium range applications.

5. Symptom:	Connected the NV-700L Master side with Slave side within 300 meters RJ-11 phone cable got only less than 10 Mbit/s.
Cause:	Some testing program which is base on TCP/IP protocol such as FTP, Iperf, NetIQ, the bandwidth of testing outcome will be limited by TCP window size.
Solution:	We recommend to test NV-700L bandwidth best by Smartbit equipment, if you don't have Smartbit, we recommend test that by IPERF program, and TCP window size must be settled max. 64k, the parameter as iperf -c server IP address -i 1 -t 50 -w 65535 for client side.

6. Question:	I just bought a NV-700L to replace my Quest DSL modem for my home. I was told any VDSL2 modem would replace and give me higher communication speeds. It doesn't get me internet when hooked up. All lights come on but no Link light. Is this the complete wrong application for this unit?
Answer:	Re: Please note NV-700L is a Master (CO side), it must be connected to the NV-700L Slave(CPE side) to work. Band profile and band plan setting must be compatible to each other .

7. Question:	What can I do if I forgot my password.
Answer:	If you forgot your password, you must reset your modem. Unfortunately this process will change all your settings back to the factory defaults. To reset the modem, locate the reset on the rear panel of the unit. With the modem powered on, use a paperclip to hold the button down for over 5 seconds. Release the button and the modem will go through its reboot process. The default ip is 192.168.16.249. When logging in, the default username and password both are "admin".

8. Question:	What is the maximum Ethernet frame MTU for these modems?
Answer:	NV-700L maximum Ethernet frame MTU is 2000 bytes.

System Diagnostics

Power and Cooling Problems

If the POWER indicator does not turn on when the power cord is plugged in, you may have a problem with the power outlet, power cord, or internal power supply as explained in the previous section. However, if the unit power is off after running for a while, check for loose power connections, power losses or surges at the power outlet. If you still cannot isolate the problem, then the internal power supply may be defective. In this case, please contact your local dealer.

Installation

Verify that all system components have been properly installed. If one or more components appear to be malfunctioning (e.g. the power cord or network cabling), test them in an alternate environment where you are sure that all the other components are functioning properly.

Transmission Mode

The default method of selecting the transmission mode for RJ-45 ports is 10/100 Mbps ETHERNET, for RJ-11 line port are auto-speed VDSL2 PTM transmission. Therefore, if the Link signal is disrupted (e.g. by unplugging the network cable and plugging it back in again, or by resetting the power), the port will try to reestablish communications with the attached device via auto-negotiation. If auto-negotiation fails, then communications are set to half duplex by default. Based on this type of commercial-standard connection policy, if you are using a full-duplex device that does not support auto-negotiation, communications can be easily lost (i.e. reset to the wrong mode) whenever the attached device is reset or experiences a power fluctuation. The best way to resolve this problem is to upgrade these devices to a version that support Ethernet and VDSL.

Physical Configuration

If problems occur after altering the network configuration, restore the original connections, and try to track the problem down by implementing the new changes, one step at a time. Ensure that cable distances and other physical aspects of the installation do not exceed recommendations.

System Integrity

As a last resort verify the switch integrity with a power-on reset. Turn the power to the switch off and then on several times. If the problem still persists and you have completed all the preceding diagnoses, then contact your dealer.

Appendix E: Compliance Information

FCC Radio Frequency Interference Statement

This equipment has been tested and found to comply with the limits for a computing device, pursuant to Part 15 of FCC rules. These limits are designed to provide reasonable protection against harmful interference when the equipment is operated in a commercial environment. This equipment generates uses and can radiate radio frequency energy and, if not installed and used in accordance with the instructions, may cause harmful interference to radio communications. However, there is no guarantee that interference will not occur in a particular installation. If this equipment does cause harmful interference to radio or television reception, which can be determined by turning the equipment off and on, the user is encouraged to try to correct the interference by one or more of the following measures:

1. Reorient or relocate the receiving antenna.
2. Increase the separation between the equipment and receiver.
3. The equipment and the receiver should be connected to outlets on separate circuits.
4. Consult the dealer or an experienced radio/television technician for help.

Changes or modifications not expressly approved by the party responsible for compliance could void the user's authority to operate the equipment.

If this telephone equipment causes harm to the telephone network, the telephone company will notify you in advance that temporary discontinuance of service may be required. But if advance notice isn't practical, the telephone company will notify the customer as soon as possible. Also, you will be advised of your right to file a complaint with the FCC if you believe it is necessary.

The telephone company may make changes in its facilities, equipment, operations or procedures that could affect the proper functioning of your equipment. If they do, you will be notified in advance in order for you to make necessary modifications to maintain uninterrupted service.

This equipment may not be used on coin service provided by the telephone company. Connection to party lines is subject to state tariffs.

FCC Warning



This equipment has been tested to comply with the limits for a **Class A** digital device, pursuant to Part 15 of the FCC Rules. These limits are designed to provide reasonable protection against harmful interference when the equipment is operated in a commercial environment. This equipment can generate, use, and radiate radio frequency energy and, if not installed and used in accordance with the instruction manual, may cause harmful interference to radio communications. Operation of this equipment in a residential area is likely to cause harmful interference in which case the user will be required to correct the interference at owner's expense.

CE Mark Warning



This is a class A product. In a domestic environment, this product may cause radio interference in which case the user may be required to take adequate measures.

RoHS Mark Warning



RoHS stands for Restriction of Hazardous Substances, and impacts the entire electronics industry and many electrical products as well. The original RoHS, also known as Directive 2002/95/EC, originated in the European Union in 2002 and restricts the use of six hazardous materials found in electrical and electronic products. All applicable products in the EU market since July 1, 2006 must pass RoHS compliance. Directive 2011/65/EU was published in 2011 by the EU, which is known as RoHS-Recast or RoHS 2. RoHS 2 includes a **CE-marking directive**, with RoHS compliance now being required for CE marking of products. RoHS 2 also added Categories 8 and 9, and has additional compliance recordkeeping requirements. Directive 2015/863 was published in 2015 by the EU, which is known as RoHS 3. RoHS 3 adds four additional restricted substances (phthalates) to the list of six.

WEEE Warning



To avoid the potential effects on the environment and human health as a result of the presence of hazardous substances in electrical and electronic equipment, end users of electrical and electronic equipment should understand the meaning of the crossed-out wheeled bin symbol. Do not dispose of WEEE as unsorted municipal waste and have to collect such WEEE separately.

Warranty

The original product that the owner delivered in this package will be free from defects in material and workmanship for one year parts after purchase.

There will be a minimal charge to replace consumable components, such as fuses, power transformers, and mechanical cooling devices. The warranty will not apply to any products which have been subjected to any misuse, neglect or accidental damage, or which contain defects which are in any way attributable to improper installation or to alteration or repairs made or performed by any person not under control of the original owner.

The above warranty is in lieu of any other warranty, whether express, implied, or statutory, including but not limited to any warranty of merchantability, fitness for a particular purpose or any warranty arising out of any proposal, specification or sample. We shall not be liable for incidental or consequential damages. We neither assume nor authorize any person to assume for it any other liability.



WARNING:

- 1.DO NOT TEAR OFF OR REMOVE THE WARRANTY STICKER AS SHOWN, OR THE WARRANTY IS VOID.**
- 2.WARRANTY VOID IF USE COMMERCIAL-GRADE POWER ADAPTER IS USED AT HARSH ENVIRONMENTS.**

Chinese SJ/T 11364-2014

部件名称	有毒有害物质或元素					
	铅(Pb)	汞(Hg)	镉(Cd)	六价铬[Cr(VI)]	多溴联苯(PBB)	多溴二苯醚(PBDE)
结构壳体	○	○	○	○	○	○
电路组	○	○	○	○	○	○
包装及配件	○	○	○	○	○	○
○：表示该有毒物质在该部件所有均质材料中的含量均在 GB/T 26572 标准规定的限量要求以下。 ×：表示该有毒物质至少在该部件的某依均质材料中的含量超出 GB/T 26572 标准规定的限量要求。						

上述规范仅适用于中国法律